



# **MOTION COMPUTING M1400 TABLET PC**

*MICROSOFT WINDOWS XP TABLET PC EDITION 2005*

*USER GUIDE*

## Copyright Information

Acrobat is a registered trademark of Adobe Systems Incorporated.

AuthenTec is a registered trademark of AuthenTec, Inc.

BLUETOOTH is a registered trademark owned by the Bluetooth SIG, Inc., U.S.A. and licensed to Motion Computing, Inc.

Broadcom is a registered trademark of the Broadcom Corporation.

Intel, Intel Inside, the Intel Inside logo, Pentium, and PROSet are trademarks or registered trademarks of Intel Corporation or its subsidiaries in the United States and other countries.

Knowles and IntelliSonic are trademarks or registered trademarks of Knowles Acoustics, Inc.

Microsoft Windows, Windows XP, Windows XP Tablet PC Edition, and Windows Journal are either registered trademarks or trademarks of Microsoft Corporation in the United States and/or other countries.

Motion Computing, Speak Anywhere, and View Anywhere are trademarks or registered trademarks of Motion Computing, Inc. in the U.S. and other countries.

OmniPass is a trademark of Softex, Inc.

PCTEL is a registered trademark of PCTEL, Inc.

Realtek is a trademark of Realtek Semiconductor Corporation.

SigmaTel is a registered trademark and Universal Jacks is a trademark of SigmaTel Corporation.

Wi-Fi is a registered trademark of the Wi-Fi Alliance.

Motion Computing, Inc. has made every effort to identify trademarked properties and owners on this page. All brands and product names used in this document are for identification purposes only and may be trademarks or registered trademarks of their respective companies.

**PATENTS:** The Motion Computing products and services may be covered by one or more of the following protected inventions. Additional patents may also be pending.

**US PATENTS:** D480,730. **OTHER PATENTS:** GB3009545, BG3009546, AUS154529, CAN101617, J1188539. For more information, see [www.motioncomputing.com/info/patents](http://www.motioncomputing.com/info/patents).

**NOTICE:** The information in this publication is subject to change without notice. MOTION COMPUTING, INC. SHALL NOT BE HELD LIABLE FOR TECHNICAL OR EDITORIAL ERRORS OR OMISSIONS CONTAINED HEREIN NOR FOR ACCIDENTAL OR CONSEQUENTIAL DAMAGES RESULTING FROM THE FURNISHING, PERFORMANCE, OR USE OF THIS MATERIAL. The information contained in this document is provided "as is" without warranty of any kind and is subject to change without notice. The warranties for Motion Products are set forth in the express limited warranty statements accompanying such products. Nothing herein should be construed as constituting an additional warranty. This publication contains information protected by copyright. No part of this publication may be photocopied or reproduced in any form without prior written consent from Motion Computing, Inc.

© 2004 Motion Computing, Inc. (August 2004)

P/N 024-02-0049 Rev. A02

## About This User Guide

### CAUTIONS, WARNINGS AND NOTICES

The following notices are found in this *User Guide*:



**WARNING:** Text set off in this way indicates that failure to follow directions in the warning could result in bodily harm or loss of life.



**CAUTION:** Text set off in this way indicates that failure to follow directions in the CAUTION could result in damage to the equipment or loss of information.

**IMPORTANT:** Text set off in this way presents information or instructions that should be followed or information of particular interest.

**NOTE:** Text set off in this way presents information or instructions.

### MENU ITEMS, BUTTONS, ICONS

Menu items, icons, and instructions found in the procedures in this *User Guide* are set apart by capitalizing them exactly as shown on screen. Examples are the Start menu, Dashboard, Tablet and Pen Settings icon, and Apply buttons.

### WRITING ON THE DISPLAY

Writing on the Motion Tablet PC digitizer display in this *User Guide* refers to any hand-written input using the specially-designed Motion digitizer pen, provided. The display responds only to this pen and not to any other type of pen or to a stylus or other device such as those used with personal digital assistants (PDAs). The display surface may be damaged by ink pens or other pointed objects.

### INK

The term *ink* refers to *digital ink*, i.e., text entered in handwritten format and converted to an object that can be displayed exactly as you write it.

### REFERENCES TO USING THE PEN AND PEN FUNCTION BUTTON

Notations for using the Motion Digitizer Pen, which are found throughout this *User Guide*, are described below:

- Tap — Tap the pen on the Tablet PC display, without pressing the function button on the pen
- Double-tap — Double-tap the pen on the display, without pressing the function button on the pen
- Right-click — Press the function button on the pen and tap the pen on the display (equivalent to a mouse right-click)
- Press and hold — Press and hold the tip of the pen to the display, without pressing the function button on the pen (same as a mouse right-click)
- Tap and drag — Tap and drag the pen on the display
- Select/Highlight — Tap on the item on the Tablet PC display with the pen to activate the function; to select a line of text, tap and drag the pen across the text to highlight it

### TASK BAR/ SYSTEM TRAY

The Microsoft Windows task bar is on the lower-left of the display; the system tray (or notification area) is on the lower right, near the clock.

# Table of Contents

About This User Guide	
Cautions, Warnings and Notices	iii
Menu Items, Buttons, Icons	iii
Writing on the Display	iii
Ink	iii
References to Using the Pen and	
Pen Function Button	iii
Task Bar/System Tray	iii
Table of Contents	v

## Chapter 1 Getting Started with Your Motion Tablet PC

Motion Tablet PC Features	1
Package Contents	2
Motion Accessories	3
What To Do First	3
Calibrate the Pen	3
Practice Using the Pen	3
Complete the Microsoft Tablet PC Tutorials	4
Motion Resources Page and Online User Guide	4
Open the Motion Dashboard	5
Microsoft Help and Resources Center Page	5
"Did You Know" Help Section (Internet Updates)	5
Take a Tour of Windows XP	6

## Chapter 2 Motion Tablet PC Hardware

Tablet PC Displays	7
Tablet PC Overview	9
Chassis and Hardtop Cover	11
Digitizer Pen	11
Motion AC Adapter	11
Motion Battery Pack	11
Front Panel Buttons	12
Modem and LAN Connectors	12
Tablet PC Chassis LEDs	13
Tablet PC Front Panel LEDs	13
Battery Status LEDs	14
Battery Status Gauge	14
Fingerprint Reader	15
Ambient Light Sensor (ALS)	15
Speak Anywhere Technology	15

PC Card Slot ..... 15  
 Wireless 802.11a/b/g Card ..... 16  
 Mini PCI Card (Wireless) ..... 16  
 Labels ..... 16

**Chapter 3 Motion Tablet PC Software**

Microsoft Software ..... 19  
 Motion Software ..... 19  
 All the software options you ordered are pre-loaded on your Tablet PC. Software installation files are in the directory c:\windows\motion. .... 19  
 Using Your Motion Tablet PC Pages and Links ..... 19  
 Motion Third-Party Software Solutions ..... 19  
 Motion CDs ..... 20  
 Motion Operating System Recovery CDs ..... 20  
 System Repair/Recovery Procedure ..... 20  
 Motion Application CD ..... 21  
 Tablet PC Software ..... 21  
 Motion Dashboard ..... 21  
 Tablet PC Input Panel (TIP) ..... 23  
 Using the Tablet Input Panel ..... 23  
 TIP Tools and Options Menu ..... 25  
 Microsoft Security ..... 25  
 Windows Security System Components Overview ..... 25

**Chapter 4 Using Your Motion Tablet PC**

Initializing Microsoft Windows XP ..... 27  
 Required Information ..... 27  
 Optional Connections, Equipment, and Information ... 27  
 Windows Initialization Procedure ..... 28  
 As your system starts up... ..... 29  
 Microsoft Office Activation (Optional) ..... 29  
 Turning the  
 Tablet PC On and Off ..... 29  
 Turning Your Tablet PC On ..... 29  
 Turning Your Tablet PC Off ..... 30  
 Opening the Motion Dashboard ..... 30  
 Conserving Power with Stand By or Hibernate Mode ... 30  
 Launching Stand By or Hibernate Mode from  
 the Start Button ..... 31  
 Launching Stand By Mode from the Motion Dashboard 31  
 Setting Up Stand By or Hibernate Mode from  
 the Power Switch ..... 31  
 Restarting from Stand By or Hibernate Mode ..... 31  
 Using the Motion Digitizer Pen ..... 31  
 Pen Notations ..... 32  
 Calibrating the Pen to Increase Its Accuracy ..... 32

Hints for Writing with the Pen . . . . .	33
Adjusting Menu Locations for Left-Handed Use . . . . .	34
Pen Gestures . . . . .	34
Working with the Tablet PC Input Panel . . . . .	34
Writing Pad . . . . .	35
Character Writing Pad . . . . .	36
On-Screen Keyboard . . . . .	37
Hints for Using the TIP Window . . . . .	38
Eliminating Paper with Windows Journal . . . . .	38
Creating Forms and Editing Them in Windows Journal . . . . .	38
Have Sticky Notes Handy for Jotting Down Information . . . . .	39
Changing Screen Orientation . . . . .	39
Customizing Buttons . . . . .	40
Ambient Light Sensor (ALS) . . . . .	41
Setting “Dynamic” Display Brightness: ALS On . . . . .	41
Setting “Fixed” Display Brightness: ALS Off . . . . .	41
Turning the Display On and Off . . . . .	41
Keeping Track of Your Battery Power . . . . .	42
Using Power Schemes . . . . .	42
Charging the Battery . . . . .	43
Swapping the Battery . . . . .	44
Disposing of Used Batteries . . . . .	44
Saving Battery Power with the Ambient Light Sensor . . . . .	44
Battery and Power Management Hints . . . . .	45
Adding Memory to Improve System Performance . . . . .	45
Installing Optical Disc Drives . . . . .	46
Optical Disc Drive Software . . . . .	46
Mirroring or Extending Your Display . . . . .	47
Connecting the Tablet PC to a Monitor or Projector . . . . .	47
Setting Up a Mirrored Desktop . . . . .	47
Setting Up an Extended Desktop . . . . .	48
Hints . . . . .	48
Creating a Screen-Resolution Scheme for an External Monitor or Similar Device . . . . .	49
Setting Up a Wireless Connection . . . . .	49
Network Management Tools For Advanced Users . . . . .	51
Bluetooth Technology . . . . .	51
Bluetooth and Your Motion Tablet PC . . . . .	51
Microsoft Bluetooth Software . . . . .	52
Bluetooth Wireless Radio . . . . .	52
Bluetooth Devices Icon . . . . .	53
Overview of the Bluetooth Device Connection Procedures . . . . .	54
PROCEDURE 1: Make the device discoverable . . . . .	54
PROCEDURE 2: Search for Bluetooth devices in range . . . . .	54
PROCEDURE 3: Exchange a passkey . . . . .	54
PROCEDURE 4. Connect the devices . . . . .	54

- Using the Bluetooth Device Wizard to Connect a Bluetooth Device (Bluetooth Keyboard Example) . . . . . 55
- Set Up a Device (Bluetooth Mouse) . . . . . 59
  - Pre-Installation Step: Check the batteries . . . . . 59
- Transferring and Receiving Files over Bluetooth . . . . . 62
  - Pre-installation step: set up a passkey . . . . . 62
  - Removing a Device from the Bluetooth Device List . . . 68
- Speak Anywhere Technology Overview . . . . . 69
  - Motion Speak Anywhere™ Technology Components . 69
  - Microsoft Speech Recognition Software . . . . . 69
  - Microsoft Sound Recorder . . . . . 70
- Audio System Controls . . . . . 70
  - Volume Controls . . . . . 70
  - Directional Controls . . . . . 70
- Setting Up Speech Recognition . . . . . 72
  - Activating the Speech Recognizer . . . . . 72
  - Setting Up Dictation or Voice Commands . . . . . 72
- Setting Up the Sound Recorder . . . . . 73
  - Using the Microsoft Sound Recorder . . . . . 73
- Multimedia Applications . . . . . 74
- About the OmniPass Password Management System . . . 75
- Overview . . . . . 75
- Basic Fingerprint Reader Set Up . . . . . 75
  - Enrolling with OmniPass . . . . . 75
  - Selecting a Finger and Practicing Fingerprint Capture . 76
  - Capturing Your Fingerprint . . . . . 77
- Advanced Fingerprint Reader Features . . . . . 79
  - Checking Logon Status . . . . . 80
  - Replacing Password Logons . . . . . 80
  - Logging Onto a Remembered Site . . . . . 82
  - Exporting Your User Profile . . . . . 82
- Microsoft Security . . . . . 82
- Setting Up Tablet PC Security . . . . . 82
  - Setting the Windows Operating System Password . . . 82
  - Setting BIOS Passwords . . . . . 82
- Clearing Tablet PC Security . . . . . 85
- Caring for Your Tablet PC and Its Accessories . . . . . 85
  - General Care . . . . . 85
  - Caring for the Standard and View Anywhere Displays . 86
  - Caring for the Motion Digitizer Pen . . . . . 86
  - Replacing the Pen Tips . . . . . 87
  - Ordering New Pens . . . . . 87
- Traveling With Your Tablet PC . . . . . 87
  - Traveling by Air . . . . . 87
  - FAA Wireless Air Travel Requirement . . . . . 88
  - Other Travel Hints . . . . . 88

**Appendix A Troubleshooting and Support**

Solutions ..... 89  
FAQs ..... 94  
Motion Warranties ..... 95  
    Standard and Extended Warranty and Insurance  
        Programs ..... 95  
Motion Computing Support ..... 95

**Appendix B Motion Tablet PC Specifications**

Specifications ..... 96

# Chapter 1

## Getting Started with Your Motion Tablet PC

Thank you for purchasing a Tablet PC from Motion Computing®! Your Motion Tablet PC combines the best features of desktop and notebook computing with the unique mobility and versatility found only in a Tablet PC.

### MOTION TABLET PC FEATURES

The Motion M1400 and M1400c Tablet PCs offer these features:

**IMPORTANT:** See the Motion Computing website at [www.motioncomputing.com/products](http://www.motioncomputing.com/products) for the most current processors, software, and other options.

- Microsoft® Windows® XP Tablet PC Edition 2005 operating system that contains a Tablet PC Input Panel (TIP) with enhanced ink-to-text experience and word recognition, and an improved security infrastructure that defends against viruses, worms, and hackers
- Intel® Ultra Low Voltage (ULV) processor and Intel 855GME chipset
- Standard 12.1-inch XGA TFT display with wide viewing angles enables clear viewing of screen images at greater than 160 degrees
- (Optional) View Anywhere™ display provides the same wide viewing angles as the standard display while significantly improving the sunlight contrast ratio and significantly reducing unwanted reflection and glare; this optimizes the display for both outdoor and indoor viewing
- Ambient Light Sensor (ALS) automatically balances display brightness
- 20GB hard drive (minimum)
- Two PC333 DDR SDRAM slots with 256MB of installed RAM, upgradeable to 2GB (M1400); upgradeable to 1GB (512 x 2) for the M1400c
- Integrated Intel PRO/Wireless 2200BG 802.11b/g
- Broadcom® 802.11a/b/g (optional; for the U.S. and Canada only)

- Integrated Bluetooth® wireless radio
- Built-in fingerprint reader for convenient, secure password management
- Speak Anywhere™ technology that combines user-configurable acoustics software with dual integrated microphones to optimize the sound capabilities of your Tablet PC
- Motion Dashboard for convenient access to Tablet PC controls
- High speed USB 2.0; fully backward compatible to USB 1.1
- Front panel status LEDs and function buttons
- Screen rotation; handwriting and voice recognition; dual-head video controller
- PC Card slot for networking, memory expansion, or accessory connections
- User-configurable power-saving schemes
- I/O ports: two audio jacks; two USB ports; IEEE 1394 port; external VGA monitor port; RJ-11 (modem); RJ-45 (Ethernet network); DC power in
- Motion Digitizer Pen for ink input, with a pen storage bay and a pen tether anchor built into the Tablet PC
- 6-cell prismatic lithium ion (Li-ion) battery
- Lightweight magnesium alloy chassis
- Kensington-type lock slot

## **PACKAGE CONTENTS**

Motion Tablet PC packages may contain the following equipment (this may change from time to time as new equipment is introduced.) See your invoice for a list of items that were shipped with the product:

- Motion M1400 or M1400c Tablet PC
- Motion Digitizer Pen, extra pen tips, and pen tip replacement tool
- AC adapter, power cord, and AC mini plug
- Motion Hardtop Cover
- Cloth for cleaning the display
- Pen tether
- System software CDs
- Product documentation

**IMPORTANT:** Check all shipping containers before discarding them to make sure you have unpacked all the items. If anything appears to be missing from your order, read the invoice to see if the part was back ordered. To check your order, contact your Motion Computing representative or call your Motion Authorized Reseller.

**MOTION  
ACCESSORIES**

Motion Computing has a complete line of accessories for your Tablet PC. Visit the Motion Computing website at [www.motioncomputing.com/accessories](http://www.motioncomputing.com/accessories) for the most current accessory list.

**WHAT TO DO  
FIRST**

After you turn on your Tablet PC and start Windows XP, you may want to take the following steps:

- Calibrate the pen.
- Practice using the pen with the Windows Journal (Start>All Programs>Tablet PC>Windows Journal).
- Complete the Microsoft Tablet PC tutorials.
- Check out the Motion Resources Page.
- Open the Motion Dashboard to quickly access many Tablet PC options.
- Open Microsoft Help and Resources Center page.
- Take the Microsoft Windows XP tour.

**Calibrate the Pen**

Your pen will function better and you will be more successful using it if you calibrate it immediately and recalibrate it occasionally. For directions, see the section "Calibrating the Pen" in Chapter 4 of this *User Guide*.

**Practice Using the Pen**

The quickest way to get a feel for using the ink capabilities of the pen is to open Windows Journal (Start>All Programs>Tablet PC>Windows Journal):

- Change the pen color, point type, and pen tip style; change the colors of the highlighter and resize it; tap on the eraser and resize it
- Tap the Selection Tool (the lasso); select and move objects on the page
- Add some space using the Insert/Remove Space option

Here are some additional hints. For others, see the section "Using the Pen" in Chapter 4 of this *User Guide*:

- When you write with the pen, you can rest your hand or arm anywhere on the display without disturbing any open programs or damaging it.
- Watch the cursor instead of the pen tip when you write. The cursor is a guide for your pen movements. If it does not align with the pen tip, you should recalibrate the pen.
- Practice writing and learn how firmly and where to tap on the Tablet PC display. You need these skills for activating programs, menus, or other Tablet PC functions.
- The pen can be held like any other writing tool. Learn how to hold it and when and how to press the function button on the pen, which activates right-click options (such as pop-up menus).



## Open the Motion Dashboard

The Motion Dashboard is an exclusive Motion Computing application from which you can access programs and functions as well as configure your Tablet PC.

To open Dashboard, select Start>All Programs>Motion Resources>Dashboard. Or, press Hot Key #1 on the Tablet PC front panel.

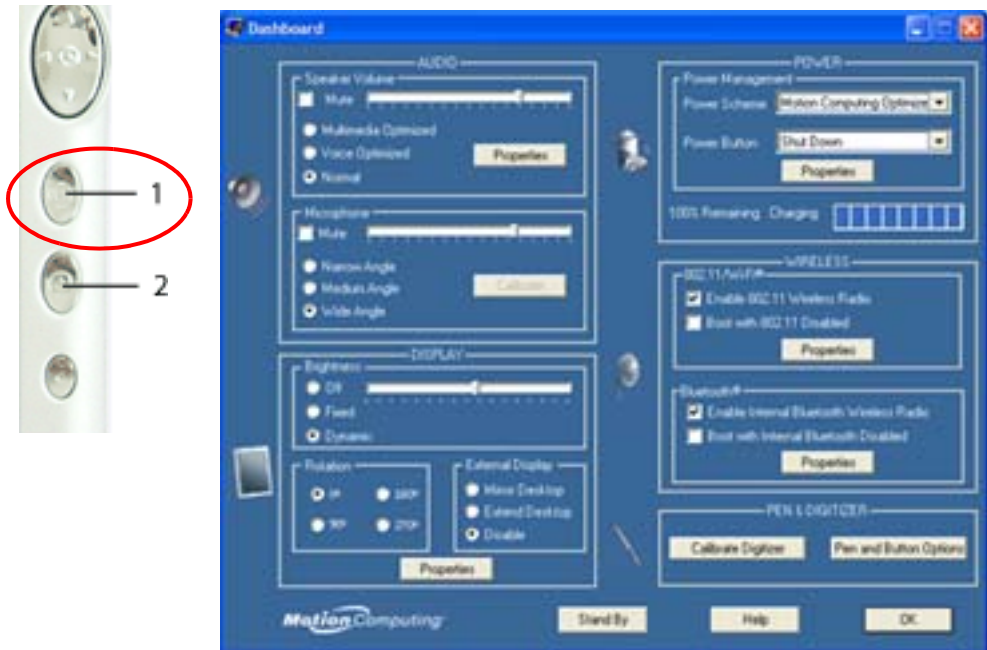

For more information about using Dashboard, see Chapter 4 of this *User Guide*.

## Microsoft Help and Resources Center Page

You can find additional information about your Tablet PC and the Windows XP Tablet PC Edition 2005 operating system in the Microsoft Help and Support Center. The Help and Support Center is installed on your Tablet PC. To access Help, select Start>Help and Support.



### ***"Did You Know" Help Section (Internet Updates)***

Whenever you open the Help and Support Center while your Tablet PC is connected to the Internet, the "Did You Know" section checks for updates

from Microsoft and Motion Computing, such as system-use hints, or notices from Motion Computing about your Tablet PC.

### Take a Tour of Windows XP

If this is your first experience with the Windows XP operating system, this tour is a good introduction. Select Start> Help and Support>What's new in Windows XP>Taking a tour or tutorial.



# Chapter 2

## Motion Tablet PC Hardware

This chapter describes the Motion Tablet PC, including hardware components, LEDs, and accessories.

### TABLET PC DISPLAYS

#### Standard Display

The standard Motion Tablet PC 12.1-inch XGA TFT display with wide viewing angles combines three key components:

- A highly-readable, liquid-crystal display
- An acrylic protective layer that offers a firm writing surface and minimizes glare
- A digitizer panel underlying the display that allows handwritten entry with a specially-designed Motion Digitizer Pen and on-screen keyboard entry



#### Standard Display Features

- A wide viewing angle display that provides brighter, clearer viewing at greater than 160-degrees, plus a high contrast ratio, fast response time, and authentic color at any angle
- A digitizer that responds to the Motion Digitizer Pen, but not to a plastic stylus or to finger touches
- A display surface that lets you touch or rest your hand on it without affecting open programs or data input

**NOTE:** For information about display care, see Chapter 4 of this *User Guide*.

## **View Anywhere™ Display Option**

The View Anywhere display option was designed to enhance indoor viewing and to improve outdoor viewing while retaining all the standard display features. The bright 12.1-inch XGA TFT display was developed from a proprietary optical enhancement process based on technology initially developed for high-end military aviation and marine applications.

### **Key Components**

- A glass protective layer that improves the sunlight contrast ratio and significantly reduces reflection and glare
- A highly-readable, liquid-crystal display (same as standard display)
- A digitizer panel underlying the display that allows handwritten entry with a specially-designed Motion Digitizer Pen and onscreen keyboard data entry (same as standard display)

### **Features of the View Anywhere Display Option**

- Like the standard display, the View Anywhere display option delivers wide viewing angles greater than 160-degrees, fast response time, and authentic color at any angle without increasing backlight consumption
- Improves the sunlight contrast ratio by 225%, which enhances viewability at wide viewing angles even further than on the standard display
- Offers enhanced optical display technology with a significant reduction in unwanted reflection and glare and a 15% improvement in light pass-through efficiency over the standard display
- Retains a similar feel of pen on paper as the standard display

**NOTE:** For more information about caring for the display, see Chapter 4 of this *User Guide*.

**TABLET PC  
OVERVIEW**

The following shows the LEDs, buttons, connectors, and other components on the Tablet PC.

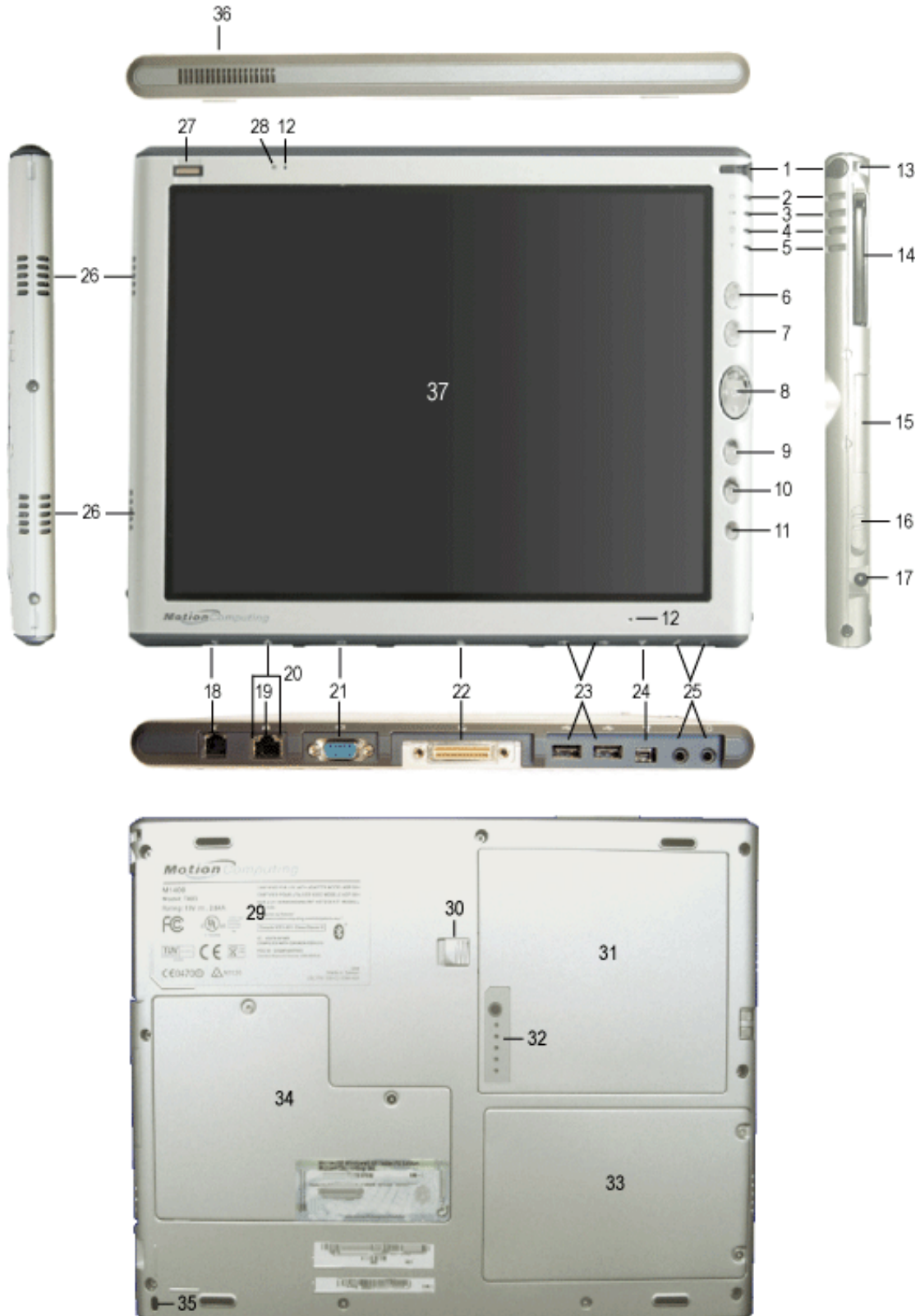

1 Pen bay	Storage area for the Motion digitizer pen
2 Power LED	Displays power status
3 Battery LED	Displays battery status
4 Hard disk drive LED	Displays Hard disk drive (HDD) activity
5 Wireless LED	Displays wireless 802.11a/b/g/ and Bluetooth activity
6 Escape button	Primary function: Esc. Secondary function: Alt+Tab
7 Function button	Press this button with another to activate Secondary button functions
8 Five-way directional control button	Primary functions: Scrolls Up/Down/Right/Left + Enter Secondary functions: Left arrow—Shift+Tab; Right arrow—Tab; Up arrow—Page Up; Down arrow—Page Down
9 Hot Key #1	Primary function: Opens the Motion Dashboard Secondary function: Opens the Windows Journal application
10 Hot Key #2	Primary function: Changes the Tablet PC display orientation Secondary function: Opens the Tablet PC Input Panel
11 Security button	Primary function: Ctrl-Alt-Del; Secondary function: None
12 Microphones (2)	Work at a natural distance; disabled when an external microphone is plugged in
13 Pen tether post	Post to which you can secure the pen with a nylon pen tether cord
14 PC Card slot	Holds one Type-II PCMCIA card for memory expansion, external WAN cards, etc.
15 Antenna cover	Wireless antenna cover; this area does not open
16 Power switch	Turns the Tablet PC on and off; can be configured to activate Hibernate or Stand By mode
17 AC power jack	AC power connector for the Motion Tablet PC
18 RJ-11 modem port	Connector for a 56.6K v.92 modem
19 RJ-45/LAN	Standard RJ-45 connector for a 10/100Mbps network
20 RJ-45 LEDs (2)	Display 10/100 LAN connection status; blink green and amber
21 VGA connector	A standard DB-15 monitor connector for an external monitor
22 Docking connector	Connects the Tablet PC with the Motion FlexDock
23 USB ports (2)	Universal Serial Bus; a port for connecting USB devices, such as a storage device, mouse, printer, or digital camera
24 IEEE 1394 port	Connects 4-pin accessories, such as DVD players, optical disc drives, video cameras
25 Audio jacks (2)	Microphone and headset plug; 3.5 mm plug
26 Speakers (2)	Integrated speakers that mute when you connect a headset or external speakers
27 Fingerprint sensor	Swipe-type sensor for scanning fingerprints; used for password management and security
28 Ambient Light Sensor	Measures the background light and automatically balances display brightness
29 Product label	Model numbers, system certifications marks, and regulatory labels
30 Battery release latch	Releases the battery from the battery bay
31 Battery	Self-monitoring battery that tracks the amount of charge
32 Battery gauge	Displays remaining battery charge
33 Hard disk drive bay	Holds the Hard Disk Drive (HDD)
34 Memory/mini-PCI wireless bay	Houses the memory modules and the mini-PCI wireless card
35 Security lock slot	Fits a cable lock for securing the unit to a desk, etc.
36 Thermal vent	Convection vent that dissipates heat from the Tablet PC
37 Display	Standard or View Anywhere XGA 12.1-inch display

**CHASSIS AND  
HARDTOP  
COVER**

The Motion Tablet PC chassis is constructed of magnesium alloy, which is lightweight, durable, and easy to maintain. The Motion Hardtop Cover is molded of a tough plastic. It snaps over the display to protect it when the Tablet PC is not in use and attaches to the bottom of the Tablet PC for storage.

**DIGITIZER PEN**

The Motion digitizer pen is a sensitive, electronic, data-entry device designed in conjunction with the Tablet PC display. It contains no batteries and requires no external power. To help prevent pen loss, attach it to the built-in pen tether post on the chassis.

**NOTE:** For best results, we recommend that you calibrate your pen before using it for the first time. For information about this and other pen procedures, see Chapter 4 of this *User Guide*.

**MOTION  
AC ADAPTER**

The Motion AC Adapter has three components:

- AC power adapter (with a right-angled connector)
- Power cord
- AC mini-plug with folding prongs for travel



**CAUTION:** Use the Motion AC Adapter with your Motion Tablet PC. This adapter should not be used to power any other electronic devices. If you do so, you may damage the accessory or other device.

**MOTION  
BATTERY PACK**

A standard-configuration Motion Tablet PC ships with a 6-cell lithium ion (Li-ion) battery pack in the battery bay. Fully charged, a new 6-cell battery pack can power the Tablet PC for about 4 hours, depending on operating conditions. Extra battery packs are available from Motion Computing.



**WARNING:** To avoid personal injury, handle the battery with care. Do not open, puncture, short, or expose it to fire or water. Keep the battery in an ambient temperature of less than +104°F (+40°C); for example, do not leave it in a closed car in hot weather for an extended time.

For additional safety information, see the *Safety and Regulatory Guide* packaged with your Tablet PC.

**NOTE:** For more information about the battery LEDs, see the section "Battery Status LEDs" in this chapter; and for more information about battery care, see Chapter 4 of this *User Guide*.

**FRONT PANEL  
BUTTONS**

The front panel of the Motion Tablet PC contains six buttons, shown in Table 2-2. Most of these buttons have both primary and secondary functions. In addition, some may be re-programmed for other functions.



Table 2-2 Button Default Functions		
Button	Primary Function	Secondary Function (Press Function + this button)
1 Escape <sup>2</sup>	Escape key	Alt + Tab
2 Function <sup>3</sup>	Function + other button activates secondary function	None
3 Five-way Directional Control Button <sup>2</sup>	Works like the arrow keys on a keyboard. The center of the button works like the Enter key.	Left arrow = Shift+Tab Right arrow = Tab Up arrow = Page Up Down arrow = Page Down
4 Hot Key #1 <sup>1 &amp; 2</sup>	Dashboard	Windows Journal
5 Hot Key #2 <sup>1 &amp; 2</sup>	Rotates the display.	Tablet PC Input Panel
6 Security <sup>3</sup>	Ctrl + Alt + Del (Windows Task Manager). Also used for domain authentication or logon screen.	None
<b>NOTE:</b> <sup>1</sup> Primary function programmable. <sup>2</sup> Secondary function programmable. <sup>3</sup> Not programmable. For information about programming buttons, see Chapter 4.		

**MODEM  
AND LAN  
CONNECTORS**

The Motion Tablet PC modem and LAN (network connection) communication ports are found on the connector edge.



**Modem and LAN Connectors:** (1) RJ-45 LEDs; (2) RJ-11 Modem; (3) RJ-45 LAN

**NOTE:** The Motion FlexDock has no built-in modem port. When using a Motion FlexDock, you must connect to the modem port on the Tablet PC through the FlexDock opening designed for this purpose.

- **Modem** (RJ-11 port) — Built-in V.92 modem that operates at a maximum of 56.6K throughput and has fax capabilities; port supports a standard phone cord connector; connect the modem only to an analog telephone jack, not to a digital telephone (PBX) network jack
- **Ethernet LAN** (RJ-45 port) — Connects a network, cable modem, or xDSL; contains two status LEDs



**CAUTION:** Do not plug a standard RJ-11 phone cord into the RJ-45 port or you may damage the RJ-45 LAN port.

**TABLET PC CHASSIS LEDs**

The Tablet PC front panel (shown in the diagram) and the battery case on the bottom of the unit contain status LEDs, described here.

**Tablet PC Front Panel LEDs**

The Motion Tablet PC has four front-panel status LEDs:



LED	Description	Status
1 Power/Stand By	Steady green	Tablet PC is on.
	Flashing green	Tablet PC is in Stand By.
2 Battery Status	See Table 2-4.	
3 Hard Disk Drive	Flashing/On	Some HDD activity
	Off	No HDD activity
4 Wireless Activity	Independently flash green and blue	Wireless is on: Green=802.11 Blue=Bluetooth
	Off	Wireless is off.

**Battery Status LEDs**

Your Motion Tablet PC is equipped with a “smart” battery that provides information about its power status, as described in Table 2-4.



**CAUTION:** To avoid personal injury, or the risk of fire or explosion if the battery is overheated, wait until the battery cools to room temperature before recharging or replacing it.

**NOTE:** If the unit is operating on battery power, you can move the pen over the Power/Battery icon (shown here and found in the system tray at the lower-right corner of the Tablet PC display) to see the number of hours of charge and the percentage of battery charge remaining.





Table 2-4 Front Panel Battery Status LED		
LED	Battery Status	Action
Steady green	Battery 100% charged (AC plugged in)	None
Steady amber	Battery charging (AC plugged in)	None
Steady red	Battery overheated or defective	Wait for the battery to cool. Replace the battery.
Flashing green and amber	Battery discharging abnormally	Replace the battery.
Slow-flashing amber	10% battery charge remaining (AC unplugged)	Immediately charge the battery to avoid loss of data.
<p><b>NOTE:</b> When the remaining battery charge is 10%, your Tablet PC issues a Low Battery alarm message in addition to the LED warning. For information about modifying this alarm (you can set it to display a message or to produce an audible warning), see Chapter 4 of this <i>User Guide</i>.</p>		
Fast-flashing amber (lasts only a few seconds)	3% battery charge remaining (AC unplugged)	The Tablet PC issues a Critical Battery alarm and automatically goes into Hibernate mode.
<p><b>NOTE:</b> Hibernate mode attempts to save data in any open programs to your hard disk drive. When you restart the Tablet PC, it should return to the same system status as before hibernation.</p>		
Off	Tablet PC is unplugged from AC power and the system is running on battery power.	Plug the Tablet PC into AC power if you want to preserve battery power.

### Battery Status Gauge

A five-LED battery gauge is located on the battery. Each LED represents approximately 20% of available power. For example, if two LEDs are on, the battery has about 40% of its power remaining.

You can activate the gauge by pushing the gray button next to the LEDs.



**FINGERPRINT READER**

The built-in fingerprint reader lets you scan your fingerprint and associate it with a password. This offers a quick and convenient way to log on to your Tablet PC, provides global password management, and protects your Tablet PC data from unauthorized access.

**AMBIENT LIGHT SENSOR (ALS)**

A built-in light sensor located on the Tablet PC front panel measures the ambient light in the environment. The system then automatically balances the brightness of the Tablet PC display in relation to the surroundings. You can set two brightness modes from the Motion Dashboard:



- Fixed — Sets the display brightness to a fixed level (ALS is off)
- Dynamic — Sets the display so that the system adjusts the brightness to the preferred level under changing lighting conditions while maintaining viewability (ALS is on)

For optimal power management benefits, set the brightness slider to the mid-point or slightly above or below mid-point.

**SPEAK ANYWHERE TECHNOLOGY**

The Motion Speak Anywhere™ technology consists of configuration and array acoustics software that supports three microphone settings on the Motion Dashboard:

- Narrow Angle — For single-person dictation
- Medium Angle — For a small meeting with several people
- Wide Angle — For a large meeting; disables all “Array Processing” or “beam-focusing” software (defined below)

The configuration software helps optimize the sound capabilities of your Tablet PC for voice recognition and Voice over IP (VoIP) by providing these benefits:

- Array Processing or “beam focusing” software — Removes all sound outside the angle of acceptance
- Noise Suppression — Removes background and ambient noise
- Acoustic Echo Cancellation (AEC) — Removes echo caused by microphone detection of the system’s speaker output and prevents feedback

**NOTE:** For more information, see Chapter 4 of this *User Guide*.

**PC CARD SLOT**

The PC Card slot, located on the button edge of the Tablet PC, holds one Type-II PC Card for networking, memory expansion, or accessory connection.

1. To install a PC Card, insert it label side up.

2. To remove a PC Card, push the button next to the slot until it pops out.
3. Push it again to eject the PC Card.

**NOTE:** Your Tablet PC ships with a plastic blank card in the PC Card slot. When the slot is not in use, we recommend that you leave the plastic blank in place.

### **WIRELESS 802.11a/b/g CARD**

The 802.11a/b/g wireless card is compatible with IEEE standard 802.11 wireless networks, allowing connection to currently deployed 802.11 networks, including 802.11a, 802.11b, and 802.11g.

- 802.11b — Widely adopted and readily available wireless card; up to 11Mbps speed; runs in 2.4GHz bandwidth; 100-150-foot range indoors
- 802.11g — New wireless technology; up to 54Mbps speed; runs in 2.4Ghz bandwidth; 100-150-foot range indoors; interoperable with 802.11b
- 802.11a — Wireless technology; up to 54Mbps speed; 25-75-foot range indoors; other benefits:
  - Runs in a less-crowded 5GHz band that is less susceptible than 802.11b/g to external interference from Bluetooth, cellular phones, and other 2.4Ghz wireless devices
  - Higher density of access points than 802.11b/g resulting in less contention for the network as fewer users connect to the same access point; this increases overall throughput.

### **MINI PCI CARD (WIRELESS)**

Your Tablet PC comes installed with a mini-PCI card for wireless communications.

### **LABELS**

Most Tablet PC identification and system labels are located on the bottom of the unit. These include serial and model numbers as well as regulatory and

approval labels. Some internal components, such as the modem, also contain their own approval labels.



**Motion Tablet PC Label Locations:** (1) System Label; (2) Product Identification; (3) Internal Modem with label; (4) Hard Disk Drive Cover (remove to access modem)

This page is blank.

# Chapter 3

## Motion Tablet PC Software

### **MICROSOFT SOFTWARE**

Your new Motion M1400 Tablet PC ships with the standard Motion software, Motion Dashboard, and Motion CDs. In addition, it contains the Microsoft Windows XP for Tablet PC Edition 2005 operating system with a Tablet PC Input Panel (TIP) that includes enhanced ink-to-text experience and word recognition, in addition to an improved security infrastructure that defends against viruses, worms, and hackers.

### **MOTION SOFTWARE**

All the software options you ordered are pre-loaded on your Tablet PC. Software installation files are in the directory `c:\windows\motion`.

### **Using Your Motion Tablet PC Pages and Links**

When you start your Tablet PC and go to Start>Using Your Motion Tablet, you will find pages that describe software applications and utilities to help you personalize and make the most of your system.

### **Motion Third-Party Software Solutions**

Visit the Motion website at [www.motioncomputing.com/products](http://www.motioncomputing.com/products) and select Software. You will find links to software solutions to purchase as well as free downloads from Motion software and service partners.

## MOTION CDS

All Motion Tablet PCs come packaged with CDs for the repair and recovery the operating system and for the installation of utilities and drivers. A separate application CD is part of Motion Pak and Office Pak software, which are optional at the time of purchase.

### Motion Operating System Recovery CDs

The Motion Operating System Recovery CDs shipped with your Tablet PC contain a complete re-install of the Windows XP Tablet PC Edition 2005 operating system, all drivers, utilities, and applications. Use the Operating System Recovery CDs when you want to reinstall your operating system. Installation instructions are provided in the “System Repair/Recovery Procedure” section and are also described on the Utilities and Drivers Readme.html and System Recovery.html files on the CDs.

### System Repair/Recovery Procedure

In most cases, once initiated, this procedure lets you repair the Tablet PC hard disk drive and retain the original system data, applications, passwords, and settings with no data loss.

In those cases where no repair is possible, this procedure overwrites your system data. You can cancel the procedure before the recovery process begins. In this case, you may want to contact your system administrator for assistance.

1. If possible, back up your data files.
2. Turn off your Tablet PC.
3. Insert the Motion M1400 Operating System Recovery CD (Windows XP Professional Service Pack 2) into the CD-ROM drive and start the Tablet PC.
4. When prompted, press any key to boot from the CD.
5. On the Setup screen, select ENTER to set up Windows XP.

**NOTE:** Do not select R=Repair before you accept the End User License Agreement (EULA). If you do, you must exit this procedure, shut down and restart your Tablet PC, then accept the EULA before proceeding.

6. Press F8 to accept the terms of the End User License Agreement.
7. When the next options appear, select from the following:

**IMPORTANT:** If Windows XP cannot repair your system, this procedure automatically skips to the second option, ESC=Don't Repair (reformatting):

- R=Repair option — Installs Windows XP Tablet PC Edition 2005 on your system, preserving your system data, applications, passwords, and settings
- ESC=Don't Repair (reformatting) option — Reformats your hard disk drive. If Windows XP automatically skips to this option (that is, no repair is possible), you must decide whether to reformat now or cancel the procedure. If you decide to reformat, select either Format the partition using the NTFS

- File System or the NTFS File System (Quick). If you decide not to reformat, select ESC to cancel the procedure.
8. Continue following the onscreen instructions.
  9. After your operating system has been reinstalled, you will be prompted to insert the Motion Utilities and Drivers Recovery CD.
    - a. For a repaired system, this process completes quickly. If your system notifies you to reboot, restart your system.
    - b. For a reformatted system, this process takes some time while the drivers and utilities are reinstalled. Once Windows loads, your settings and drivers begin to install. Your system may reboot several times during this process. No action is required. At this point, you may need to install additional software (such as Microsoft Office), as appropriate, from the Motion Application CD. You may also want to restore your personal preferences and settings.

### Motion Application CD

(part of Motion Pak and Office Pak software, which are optional at the time of purchase) The Motion Application CD contains the software applications that were originally installed on your Tablet PC. Installation instructions are in the Readme.html file on the CD.

### TABLET PC SOFTWARE

Your Tablet PC contains software applications to enhance its operations.

### Motion Dashboard

The Motion Dashboard puts many operations at your fingertips for convenient access.

To display the Motion Dashboard, press Hot Key #1.

**NOTE:** Dashboard contains no "Apply" button. When you change a setting on Dashboard, the change occurs

immediately. Tapping "OK" on the Motion Dashboard only closes the window. (If you disable your wireless connection from Dashboard, it may still appear to be working for a short time, that is, the wireless LED may continue to blink for a few seconds. This is a timing delay; the connection will disappear quickly.)



**Table 3-1  
Motion Dashboard Features**

Feature	Description
Speaker Volume	<p>Available Settings:</p> <ul style="list-style-type: none"> <li>• Mute the speaker sound; sliding scale changes speaker volume</li> <li>• Multimedia Optimized — Best equalization setting for sound reproduction from the Tablet PC, CD player, DVD, or sound recorder</li> <li>• Voice Optimized — Best setting for voice reproduction from the Tablet PC speakers</li> <li>• Normal — Best setting for external speakers or headphones</li> <li>• Properties — Adjusts the volume; balances the left and right speakers and bass and treble settings for multimedia applications, such as a CD player, DVD, or sound recorder. Select Volume Control&gt;Options&gt;Properties to set Playback and Recording for a selected device.</li> </ul>
Microphone	<p>Available Settings:</p> <ul style="list-style-type: none"> <li>• Mute — Sliding scale changes microphone volume</li> <li>• Narrow Focus — Best setting for dictation, Voice over IP (VoIP), or “voice noisy” environments; the microphone focus is on a spot near the center of the display</li> <li>• Medium Focus — Best setting for small group, conference table, or “voice quiet” environments; the microphone detects sounds from a larger area</li> <li>• Wide Focus — Best setting for open meeting room; array processing software is turned off</li> <li>• Calibrate — Focuses the microphones on sounds from a particular location</li> </ul> <p><b>NOTE:</b> The microphones keep their settings until you recalibrate them or change the angle of acceptance.</p>
Brightness	<p>The built-in Ambient Light Sensor (ALS) detects light in the environment and automatically adjusts the display brightness.</p> <p>Available Settings:</p> <ul style="list-style-type: none"> <li>• Off — Turns off the display back light</li> <li>• Fixed — Maintains a fixed brightness level on the display that remains constant under varying light conditions</li> <li>• Dynamic — Uses ALS to maintain a relative brightness level on the display in varying light conditions</li> </ul> <p><b>NOTE:</b> For optimal battery life benefits and viewability from ALS, set the brightness scale to the mid-point or slightly above or below mid-point. If the setting is higher than this, you lose some of the battery-saving benefits while gaining minimal improvement in viewability.</p>
Rotation	Sets the Tablet PC display orientation (rotation)
External Display	<p>The Tablet PC has a dual-head video controller that can “mirror” the Tablet PC display or extend it to a second monitor or external device, such as a data projector. This feature is disabled by default.</p> <p>Available Settings:</p> <ul style="list-style-type: none"> <li>• Mirror Desktop — Clones or duplicates the Tablet PC display on another monitor or projector</li> <li>• Extend Desktop — Enlarges the overall desktop work space to include both external monitor and the Tablet PC display</li> </ul>
Power Management	Lets you set power schemes and power button options; also displays battery power; controls for wireless connections

Wireless	<p>“On/Off” settings for the wireless devices built into the Tablet PC</p> <p>Available Settings:</p> <ul style="list-style-type: none"> <li>• Enables/Disables the 802.11/Wi-Fi and/or Bluetooth Wireless Radio</li> <li>• Disables either or both wireless devices at Tablet PC start up (useful in settings that prohibit wireless operations, such as while traveling on airplanes or in medical locations)</li> </ul>
Pen & Digitizer	<p>Available Options-:</p> <ul style="list-style-type: none"> <li>• Calibrates the pen to the display</li> <li>• Pen and Button Options — Changes Tablet PC, pen, and button properties, such as hot-key assignments, right/left handedness, or the right-click function</li> </ul>
Stand By	<p>Puts the Tablet PC in low-power Stand By mode for a temporary suspension from which you can quickly resume your Windows session.</p>
Help	<p>Displays Motion Dashboard Help.</p>

### Tablet PC Input Panel (TIP)

The Tablet PC Input Panel (TIP) is a primary tool for entering text and provides several text correction and control options. The TIP is most easily accessed from an icon that floats near where text is being entered on the display. In this example, the TIP icon floats near the “New Folder” that has just been opened and can be conveniently accessed to write in a folder name.

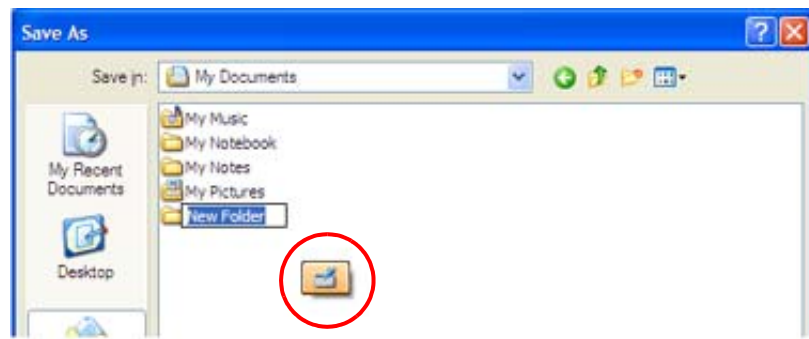

You can also open the TIP from the icon in the Windows task bar .

### Using the Tablet Input Panel

You can input data in three ways from the TIP:

- **Writing Pad** — Lets you handwrite on the recognition window, scratch out a letter or number and rewrite it; interprets and displays handwriting as text below the writing line; also lets you select an alternate word from a drop-down list to simplify correction before converting it to text or add it to the dictionary.

**NOTE:** Adding words to the dictionary improves recognition accuracy. This is because the Tablet PC does not actually learn to recognize your handwriting but instead learns your vocabulary.



- **Character Writing Pad** — Let you handwrite letters, numbers or symbols that the writing pad might otherwise misinterpret, such as, acronyms, serial numbers, web addresses, or characters such as ~<!<@<#<\$<%<^ &\*( )\_+<>{ } [ ] \ / . Like the writing pad, characters are interpreted and displayed as text below the writing line; scratch out a letter, number, or symbol and rewrite it; select an alternate characters or symbol from a drop-down list.

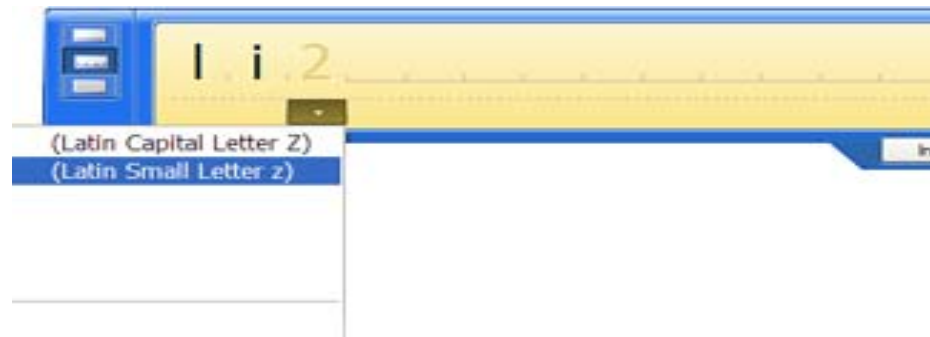

- **On-Screen Keyboard** — Lets you type words, letters, numbers, and characters from the on-screen keyboard with your pen.

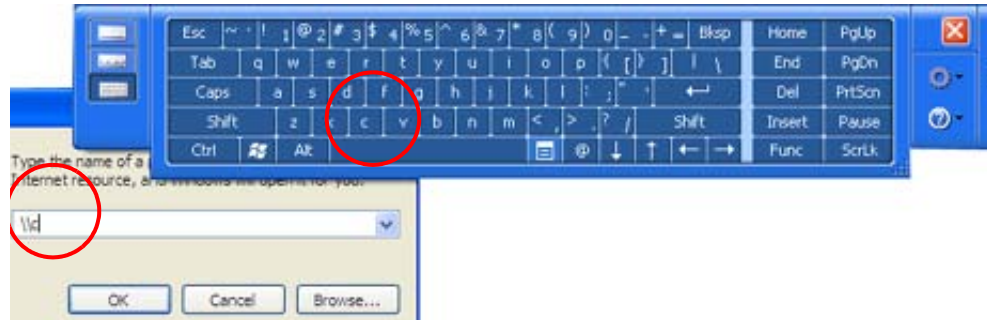

### TIP Tools and Options Menu



- **Speech** — Complete the Speech Recognition Enrollment that adjusts the microphones and trains the Tablet PC speech recognition; set up speech features
- **Dock at Top/Bottom of Screen** — Relocate the TIP panel on the display
- **Options** — Change the appearance and handwriting recognition characteristics of the Writing and Character pads; change options such as where and how the Insert button works; set gestures for different languages



**NOTE:** For more information about setting up speech recognition through the Tablet PC Input Panel, see Chapter 4 of this *User Guide*.

## MICROSOFT SECURITY



The Windows XP for Tablet PC Edition 2005 operating system provides new security features that defend against viruses, worms, and hackers. To learn more about these features, go to Start>Control Panel>Security Center or tap the Windows Security Alerts icon in the system tray (this icon only remains active for a short time on your desktop).

### Windows Security System Components Overview

Among the new security features, the Security Center automatically sets up a Windows Firewall on your Tablet PC to block unwanted access to your system over the internet and from other networks. The Security Center system provides security alerts during startup and messages while running Internet Explorer. These messages are a normal part of the operating system. Microsoft provides information with these alerts to help you decide what action to take.

In addition, you can set up the firewall to block all outside sources from connecting to your system (recommended) or can make exceptions to allow communications with a certain program. Within these settings, you can

change the scope to specify a set of computers for which this port or program is unblocked.

- **Security Center** — Lets you check security settings and learn more about improving security. Access from Start>All Programs>Accessories>System Tools>Security Center. 
- **Windows Firewall** — On by default; helps protect your Tablet PC against viruses and other security threats, such as intruders who might try to access over the Internet or a network. Tap the Windows Firewall icon on the Control Panel (Classic view) or the Security Center>Windows Firewall icon (Category view). From here, you can add exceptions to bypass selected programs and services. If a program or service needs to open the firewall to perform, it notifies you and lets you decide whether to open the firewall and allow access. 
- **Automatic Updates** — Checks for the latest important updates and install them automatically. Configure from the Security Center.
- **Internet Explorer** — Provides security settings to warn you about viruses and other security threats that can spread over the Internet; blocks certain Web site features and gives you a warning, so you can decide whether it is safe to proceed. Access from Internet Explorer Tools>Internet Options>Security. You can always bypass the settings for sites of your choice by changing the options for that site.
- **Pop-up blocker in Internet Explorer** — Stops most browser windows that Web sites pop up without your permission, giving you more control over your Web browsing experience. Access from Internet Explorer Tools>Internet Options>Security. You can always bypass the settings for sites of your choice by changing the options for that site.

# Chapter 4

## Using Your Motion Tablet PC

This chapter describes various procedures and functions that your Motion Tablet PC performs.

### **INITIALIZING MICROSOFT WINDOWS XP**

Your Tablet PC comes with pre-installed software applications and drivers, including those for the Windows XP Tablet PC Edition 2005 operating system. The first time you start your Tablet PC, you must initialize Windows XP. The steps for initializing the software are described in the following sections.

#### **Required Information**

- Computer name (you can create this yourself or obtain one from your system administrator)

#### **Optional Connections, Equipment, and Information**

- Internet access
- Motion AC Power Adapter
- Administrative password
- Description of your computer
- Company name
- Network settings
- Domain name
- Names of the people who will be using this Tablet PC
- Microsoft Office Product Keys (if you are installing Microsoft Office products, such as Word, Excel, or PowerPoint)

## Windows Initialization Procedure

**IMPORTANT:** You do NOT need Internet access to initialize Windows. When the Windows initialization procedure prompts you for this information, you can either select “Skip” or the option that lets you set up Internet access later.

1. (Recommended) Connect your Tablet PC to AC power. (This ensures continuous power during this initialization procedure and in case the battery is low.)
2. Slide the power switch to start the Tablet PC. After a short time, the “Welcome to Microsoft Windows” screen appears.
3. Tap Next.
4. Set up the dates and currency.
5. Tap Next.
6. Select the time zone.
7. Tap Next. The End User License Agreements (EULAs) for Microsoft Windows XP and for Motion Computing appear.
8. Select “Yes, I Accept” to the End User License Agreements.
9. Tap Next.
10. Type in a name for your computer. Enter the name provided by your network administrator or a unique name you make up.
11. (Optional) Type in a description of your computer. Select Next.
12. When asked what your Administrator password is, enter a password of your choice or one that was assigned to you. This will be the password for the Administrator account on your Tablet PC.
13. Select Next.
14. (Optional) Type in the domain name (from your network Administrator). If you do not have a domain name, tap Next.
15. (Optional; you do not need Internet access to initialize Windows) After Windows checks for Internet connection, select Skip to set up Internet access later.
16. Select “Yes, Ready to activate Windows.”
17. Select Next.
18. (Optional) “Ready to register with Microsoft.” Select “Yes.” (You can register now, but you must have Internet access.)
19. Select Next.
20. (Optional) Enter the Registration Information or select Skip. If you enter this information, select Next.
21. (Optional) You may get a message “Unable to connect to the Internet.” Select Skip since you have not set up Internet access.
22. Type your name in the space provided. Enter at least one name in this space, which will be the name of the User account on your Tablet PC. (If others will be using this Tablet PC, add in their names here [up to a total of five]. You can add users and passwords later through the Windows Control Panel if you wish.)
23. Select Next. This message appears:

Thank you! Congratulations, you’re ready to go!

24. Select Finish. This message appears:

Windows XP  
Please wait.  
Windows is starting up.....

This completes the Windows XP initialization. Please keep reading...

### ***As your system starts up....***

As your system starts up, it displays messages, some of which require action, while others do not.

- Windows may discover, load, and install new hardware. When prompted and as appropriate for your system, answer Yes or OK.
- An Automatically Update message may appear. You must be connect to the Internet to update now. You can close this window and update later.
- Tablet PC Tutorials screens are displayed. Run these now or later.

**Windows Logon:** The Windows logon screen prompts you to “click your user name” (see Step 23). All the user accounts you created are displayed here. Select the user name you want to log on with.

**OmniPass Logon Authentication:** This OmniPass dialog for the Fingerprint reader, although visible, is not active until you enroll with OmniPass.

- For enrollment information and information about setting up a Windows password for your user account, see the section “About the OmniPass Password Management System” in this chapter.
- For OmniPass Help, right click the OmniPass key icon in system tray and select Help. (If the key icon does not appear, you may need to reboot your system and start the enrollment again.)

### **Microsoft Office Activation (Optional)**

If you ordered the Microsoft Office XP 2003 Small Business Edition software with your Tablet PC system, all the necessary software it is already installed. To activate Microsoft Office, follow these steps:

1. Open a Microsoft Office application, such as Microsoft Word.
2. A screen appears, prompting you to enter your User name, Initials, Organization, and the 25-character Product Key. The Product Key is printed on the Microsoft Office CD packaged with your Tablet PC.
3. Follow the onscreen messages to activate Microsoft Office.

## **TURNING THE TABLET PC ON AND OFF**

### **Turning Your Tablet PC On**

Start the Tablet PC by sliding the power switch. The power LED turns green and the Hard Disk Drive (HDD) LED intermittently flashes green. Then Windows XP launches.

When you start the Tablet PC, the Windows XP Tablet PC Edition 2005 Tutorials screen appears. If you do not want this to continue to appear, check “Do not show me this again.” We recommend that you complete the Microsoft tutorials, which take a few minutes. If you do not want to run the tutorials now, you can always return to them by tapping Start>Using Your Motion Tablet PC.

### Turning Your Tablet PC Off

The recommended way to shut down your Tablet PC is by selecting Start and then Shut Down. Alternately, you can force a shutdown by pressing and holding the power switch for about 5 seconds. (You can change the function of this button so it puts the system into Stand By or Hibernate mode. See the section “Conserving Power with Stand By or Hibernate Mode” in this chapter. These modes preserve your Tablet PC settings, when possible.)

**IMPORTANT:** Use a forced shutdown only when the system is completely unresponsive to software commands. If you have any applications open or any unsaved work, you will lose it. Windows will not prompt you to save your work if you force a shutdown.

### OPENING THE MOTION DASHBOARD



In the following sections, you will be instructed to open the Motion Dashboard. To do this, press Hot Key #1 (1) on the Tablet PC front panel.

You can also access Dashboard by selecting Start>All Programs>Motion Resources>Dashboard.

The Motion Dashboard offers many Tablet PC functions in a convenient location.



### CONSERVING POWER WITH STAND BY OR HIBERNATE MODE

Low-power Stand By or Hibernate mode can conserve Tablet PC power, important when running on battery. Each is designed to preserve your Tablet PC settings, when possible, so you can resume work where you left off.

- **Stand By** — Greatly reduces Tablet PC power consumption and restarts within a few seconds. Choose Stand By when you plan to return to work within a short time (a few minutes to a few hours) and want to conserve power.
- **Hibernate** — Completely shuts down the Tablet PC to conserve power. It takes slightly longer to restart from Hibernate than from Stand By

mode. Choose Hibernate when you plan to stop work for longer periods of time, such as overnight. This setting saves the status of the Tablet PC system to the hard disk drive.

### Launching Stand By or Hibernate Mode from the Start Button

1. Select Start>Shut Down.
2. From the pop-up window, open the drop-down menu and select Stand By. (If you are not on a domain, the pop-up window displays icons for Stand By/Turn Off/Restart. Press the Shift key on the keyboard and toggle to Hibernate.)
3. The Tablet PC will then enter Stand By or Hibernate. In Stand By, the power LED flashes green. In Hibernate, all the status LEDs are off.

**IMPORTANT:** You can put the Tablet PC in either Stand By or Hibernate to swap the battery. See the section “Swapping the Battery” in this chapter.

### Launching Stand By Mode from the Motion Dashboard

Open the Motion Dashboard and then tap the Stand By button.

### Setting Up Stand By or Hibernate Mode from the Power Switch

When you slide the power switch, by default your Tablet PC shuts down. You can change this setting so that you can enter either Stand By or Hibernate from the power switch.

1. Open the Motion Dashboard.
2. On the Dashboard, under Power Management, tap the down arrow beside the Power Button.
3. From the drop-down menu, select Stand By or Hibernate, as desired. The setting goes into effect immediately.
4. Tap OK to close Dashboard.

### Restarting from Stand By or Hibernate Mode

To restart from Stand By or Hibernate mode, briefly slide the power switch until the Tablet PC display turns on. Tap your user name to resume work.

#### USING THE MOTION DIGITIZER PEN



The Motion Digitizer Pen contains internal electronics that let you enter digital ink on the Tablet PC display. Finger-tapping or writing with a PDA stylus has no effect. The pen contains a pen function button, used for right-clicking (like a mouse) and a small opening at one end for attaching a pen tether cord. The pen also comes with replacement pen tips and a replacement tool. For information about replacing the pen tips, see “Replacing the Pen Tips” in this chapter.

## Pen Notations

- Tap — Firmly tap the pen on the Tablet PC display, without pressing the function button on the pen
- Double-tap — Tap the pen twice on the display, without pressing the function button on the pen
- Right-click — Press the function button on the pen and tap the pen on the display (equals a mouse right-click). For more information about using the pen function button, see the section “Writing with the Pen” in this chapter.
- Press and hold — Press and hold the tip of the pen to the display without pressing the pen function button (equivalent to a mouse right-click)
- Tap and drag — Tap and drag the pen on the display
- Select/Highlight — Tap on the item on the Tablet PC display with the pen to activate the function

## Calibrating the Pen to Increase Its Accuracy

Be sure to calibrate your pen in both portrait and landscape orientations the first time you start your Tablet PC, then at other times if the cursor does not seem to line up with the pen tip. Calibration ensures the accuracy of the pen and adjusts the Tablet PC display for each person who uses it. The Tablet PC stores pen calibration and settings on a per-user basis.

1. Open the Motion Dashboard and tap Calibrate Digitizer. Or double-tap the Tablet and Pen Settings icon in the system tray, located in the lower right-hand corner of the display window. This opens the Tablet and Pen Settings window.



**NOTE:** This icon may be hidden in the system tray. Tap the system tray left-arrow to open all hidden icons.



2. Carefully tap the pen point *precisely* in the center of each of the four calibration crosshairs as they appear. During calibration, try to position the Tablet PC as close to the way you will use it as possible, whether holding it in portrait or landscape orientation or using it in a FlexDock or Hardtop Keyboard. Remember that changing pen or display angles affects the calibration.
3. Rotate the Tablet PC display and repeat as needed for another orientation.



## Hints for Writing with the Pen

The first time you pick up the pen, you may notice how lightweight it is (it has no internal battery), the plastic tip, and the elongated button, called the “function button.”

- You can hold the pen like any other writing tool, except you may want to place your fingers on either side of the pen function button so you do not inadvertently press it when you write. Pressing the function button while tapping the pen on the display is like right-clicking with a mouse and will launch pop-up menus or may otherwise interfere with your writing or drawing.
- Practice pressing the pen function button with both your index finger and thumb to see which you prefer.
- Relax your grip. Only a light touch is needed to write with the pen.
- With a little practice, you will learn how hard to tap to activate buttons and menus.
- For tips for improving handwriting recognition, see the section “Working with the Tablet PC Input Panel.”
- When writing with ink (such as in Windows Journal), a pointer (small dot) appears under the pen tip on the display. The location of this dot in relation to the pen tip depends on the current pen and display angles as well as how well you calibrated the display to these angles.
- When using the pen as an arrow cursor, if you need to determine if you are in the right place to select a menu item, for example, look at the position of the pointer, not where the pen touches the display.



**CAUTION:** Do not write on the Tablet PC display with ink pens or other sharp objects that could damage it. Do not use permanent markers that may damage the display.

A comparison of the pen and mouse operations is made below:

<b>With a Mouse</b>	<b>With the Digitizer Pen</b>
Point and click	Point and tap the pen on the display.
Double-click	Double-tap the pen on the display.
Click-and-drag	Tap-and-drag the pen on the display.
Right-click	Press the pen button while tapping, or press and hold the pen on the display.

## Ending Accidental Right-Clicks

If you find that you accidentally press the pen button when you write, you may want to deactivate this option. (You will still be able to open right-click menus by pressing and holding the pen against the display surface.)

1. Open Dashboard and tap Pen and Button Options. (You can also double-tap the Tablet and Pen Settings icon in the system tray, located in the lower right-hand corner of the



display window; or tap the icon and select Properties. Or, open it through the Windows Control Panel.)

2. Select the Pen Options tab.
3. Uncheck the option “Use pen button to right-click.”
4. Tap Apply.

### Adjusting Menu Locations for Left-Handed Use

For convenience, you can adjust the handedness and menu locations for left-handed use.

1. Repeat Steps 1 and 2 above.
2. Select the Settings tab.
3. Change the Handedness or Menu location, as desired.
4. Tap Apply.



### Pen Gestures

You can use pen gestures to quickly perform the following actions:

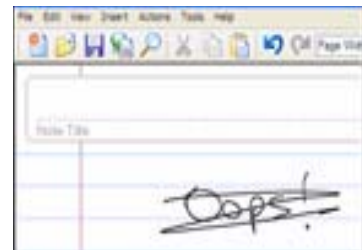

**NOTE:** For more information about gestures, gesture symbols, and for handwriting tips, open the Tablet PC Input Panel>Help>Help Topics>Tips and Tricks>Tips for entering text. Under Related Topics is a Gesture reference list.

- **Open the Tablet PC Input Panel (TIP)** — Hold the tip of the pen above the screen and quickly move the pointer back and forth several times until the TIP opens.
- **Backspace** (erase the previous character) — Quickly draw a right-to-left line on the TIP surface where you are entering text
- **Erase** — Draw a short, wide “Z” from left to right across what you want to erase. (It may take some practice to master this gesture.) The erase gesture works in the Windows Journal and the TIP.



### WORKING WITH THE TABLET PC INPUT PANEL

The Tablet PC Input Panel (TIP) is a primary tool for entering text and provides several text correction and control options. It is most easily opened

from a small icon  that floats near where you are entering text as you move your pen close to the display. (You can also open the TIP from the TIP icon  in the Windows task bar.)

This example shows how the icon appears in a “Save As” window as you would enter the name of the New Folder.

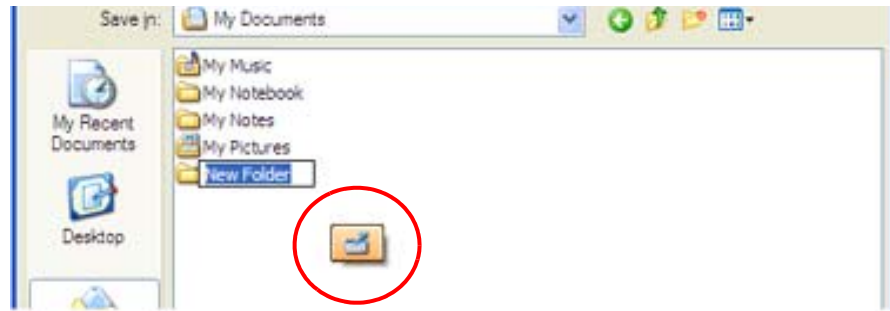

When you tap this icon, the Writing Pad opens. As you write, the recognition software interprets the writing and displays a text equivalent below the line.



- 1 You can change from the Writing Pad (1) to a Character Writing Pad (2) or On-Screen Keyboard (3) at any time by selecting these from the input bar shown here.
- 2
- 3

## Writing Pad

As you write, the software selects the best match for a word from its “dictionary” of words and displays it on screen. Tap on a word to select it.

In this example, either handwrite directly over the incorrect character or tap the character to open a list of alternatives (as shown here: O, 0, a, 6).

**IMPORTANT:** If this word is not in the dictionary, you can select Add to Dictionary so it will be recognized the next time you write it.



The Writing Pad expands to show Num (numbers) or Sym (Symbols) toolbars, whose symbols are inserted immediately in the text entry area as you select them. Then, when you begin to handwrite on the Writing Pad, the Num or Sym toolbar closes.

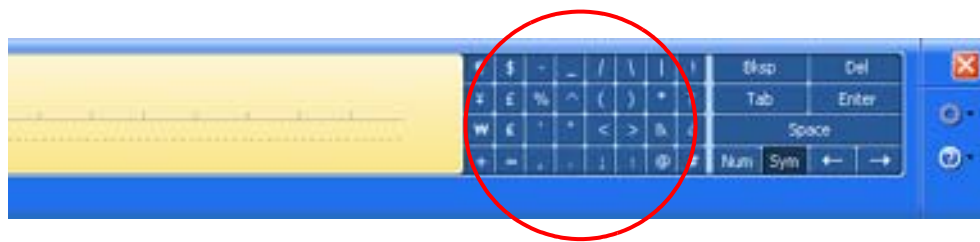

### Character Writing Pad

Use the Character Writing Pad for acronyms, equations, or other entries that require individual letters, numbers, or symbols that the writing pad may interpret incorrectly. Some examples are: ~<!<@<#<\$<%<^ &\*(\*)\_+<>{ } [ ] \/. Symbols/letters are displayed in a text equivalent that you can individually correct by:

- Handwriting over the text equivalent
- Clicking on the arrow under the letter and selecting an alternative from the drop-down menu

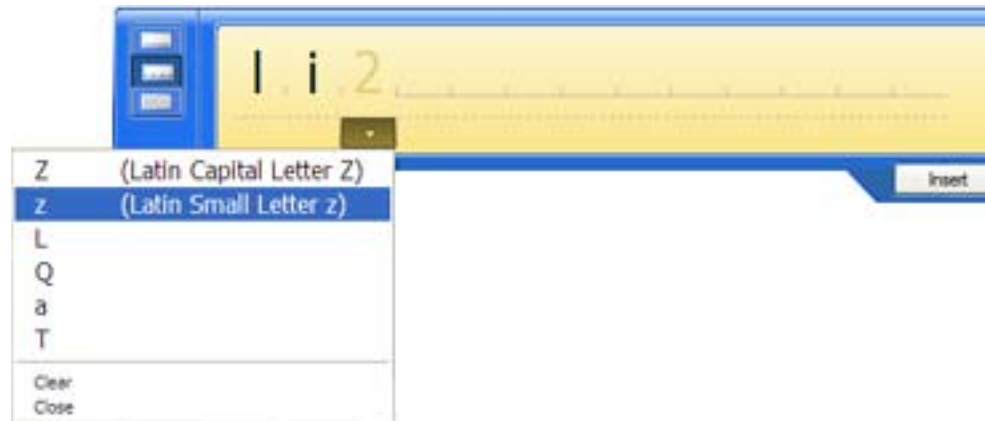

The display expands as additional space is needed.



### On-Screen Keyboard

You can use the On-Screen Keyboard to type words, letters, numbers, and characters from the on-screen keyboard with your pen. For security and accuracy, you may want to enter passwords here.

**NOTE:** When using the On-Screen Keyboard, be sure to place your cursor where you want to enter text in the text entry box.

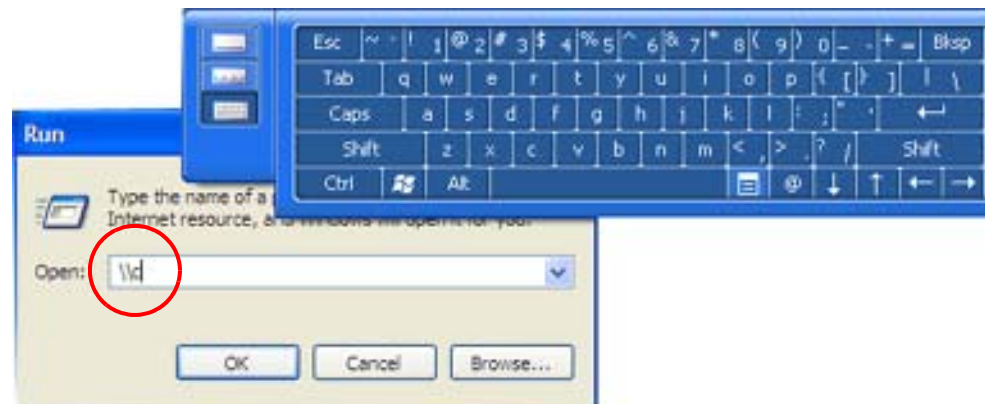

### Hints for Using the TIP Window

- Move the TIP panel on your desktop using the bar on the right.

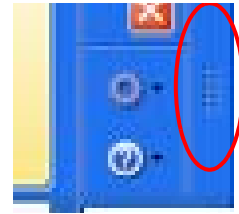

- Customizing — Select Tools>Options... from the TIP window to customize many features in the TIP.

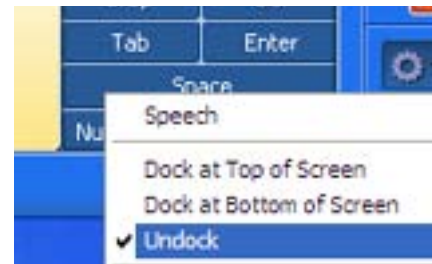

### ELIMINATING PAPER WITH WINDOWS JOURNAL

Windows Journal offers these note-taking capabilities:

- Search — Look for a handwritten or typewritten word in all your Journal Notes
- Organization — Use color, and/or titles to arrange information
- Versatility — Draw diagrams and charts, copy and paste information between documents, convert handwriting to text

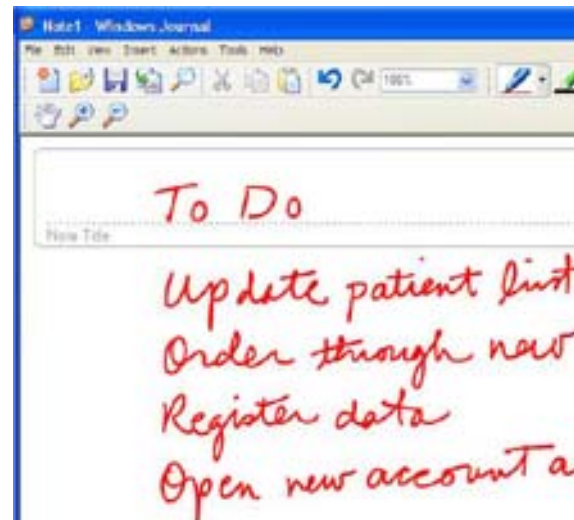

### CREATING FORMS AND EDITING THEM IN WINDOWS JOURNAL

You can create forms from your documents by creating a Journal template from the “Print” command. You can then write on this “form” with digital ink during a presentation or editing and e-mail it to others to read your annotations.

1. Open Windows Journal from Start>All Programs>Tablet PC.
2. Create or open the desired document on your Tablet PC in the application of your choice.
3. Tap Print.
4. Select the Journal Note Writer as the printer.
5. Tap Print.
6. On the Save As screen, type in a name for the document.

7. Tap Save. By default, this saves your document as a Windows Journal template (.JNT file) to My Documents/My Notes unless you select another path.

**NOTE:** Windows Journal may take a few minutes to save, but even multi-page documents will convert to a Journal Note Writer file.

8. If Windows Journal does not open your document automatically (an option on the Save as page can be checked to “View note” after printing), then open your Journal document manually.
9. Write with your pen on this document as you would any other Journal document (fill in your “form” or make your annotations).
10. Save your document with a new file name to preserve your edits. You can save and reuse this document as many times as you want.

### HAVE STICKY NOTES HANDY FOR JOTTING DOWN INFORMATION

Sticky Notes provide a convenient way to store information like names, phone numbers, simple maps, or other information that you would normally put on a paper note. And since they are electronic, you can export them to other programs. Sticky Notes are kept in a numbered stack that you can browse through and discard when you are through with them.

They can also be used to record voice notes (although you cannot drag the voice notes to another program or the desktop).

Open Windows Journal from Start>All Programs>Sticky Notes.



### CHANGING SCREEN ORIENTATION



To change the display orientation:

- From the Motion Dashboard
  1. Press Hot # Key 1 (1) on the Tablet PC chassis to open the Motion Dashboard.
  2. Select the orientation: 0°, 90°, 180°, or 270°
- From the Tablet PC chassis
  1. Press Hot # Key 2 (2) on the Tablet PC chassis. Each time you press this key, the display rotates 90°.
  2. Rotate the display to the desired orientation.
- From the Tablet and Pen Settings Screen
  1. Tap the Tablet and Pen Settings icon on the system tray, located at the bottom right of the display window. Or, go to the Control Panel and select the Tablet and Pen Settings icon.
  2. From the Tablet and Pen Settings window, select the Display tab.
  3. Tap the down-arrow next to Orientation.
  4. Select the desired orientation: Primary landscape, Primary portrait, Secondary Landscape, Secondary portrait.

## CUSTOMIZING BUTTONS



You can customize the Tablet PC buttons so they perform the functions that you want. The default button settings of all the buttons are described in Chapter 2 of this *User Guide*.

- 1-Escape button (Secondary function is programmable)
- 2-Function button (not programmable)
- 3-Five-way directional control buttons (Secondary functions of each key are programmable)
- 4 & 5-Hot Keys 1 & 2 (Primary and Secondary functions are programmable)
- 6-Security (Ctrl+Alt+Del) (not programmable)

To change the default button properties:

1. Open Dashboard and tap Pen and Button Options. Or, double-tap the Tablet and Pen Settings icon in the system tray, located in the lower right-hand corner of the display window.
2. Tap Tablet Buttons.
3. Highlight the name of the Tablet Button you want to reprogram. The button being programmed turns red.
4. Select Change.
5. On the Change Button Functions window, tap the down-arrow beside Action. This opens the list of actions.
6. Select a new action from the list.

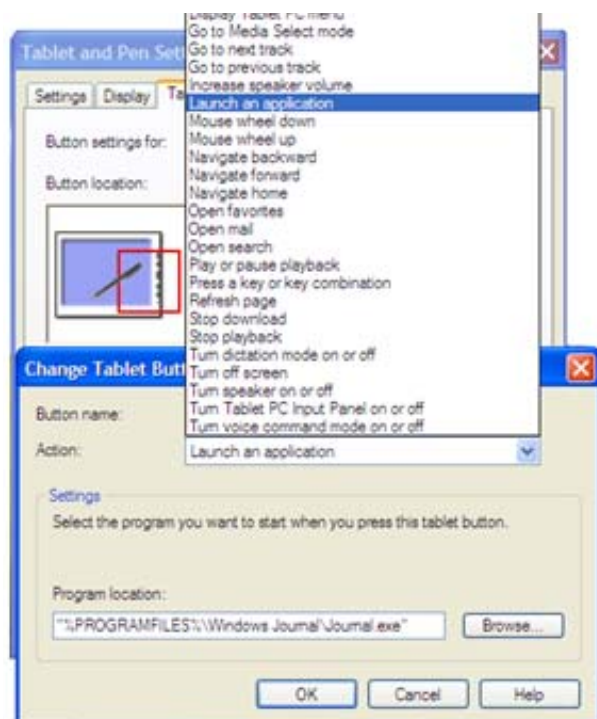

**NOTE:** For some actions, you only need to select the action itself to change the button property. For others, such as to launch a program, you must browse and find the program; or, to set up a key combination, you must press a sequence of keys. You can also reset the button defaults.

7. Select OK. In the list of Actions, you should now see the new action for the button you programmed.

**AMBIENT LIGHT SENSOR (ALS)**

The Ambient Light Sensor (ALS) is located on the front panel of the Tablet PC and detects light in the environment. When enabled, it adjusts the display brightness to changing light conditions. ALS maintains display viewability and can decrease power consumption as the system optimizes the display in different lighting conditions, thus reducing power use whenever lighting conditions allow.

**NOTE:** For optimal power management benefits and viewability, set the brightness slider to the mid-point or slightly above or below mid-point. If you set the slider higher than this, you lose some of the power management benefits, while gaining minimal improvement in viewability.

**Setting “Dynamic” Display Brightness: ALS On**

When you turn on ALS, the display will automatically brighten if you move from dim to bright light (within the range supported by the hardware); or automatically dim if you move from bright light to dim. This helps improve viewability and reduces power use when possible.

1. Open the Motion Dashboard.
2. Under Display, tap the radio button beside Dynamic.
3. Move the slider until the Tablet PC display is at the preferred level. The system will then automatically adjust the display brightness to changes in lighting.

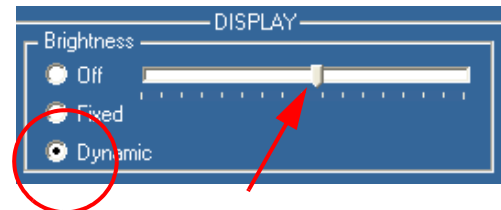
**Setting “Fixed” Display Brightness: ALS Off**

1. Open the Motion Dashboard.
2. Under Display, tap the radio button beside Fixed.
3. Move the slider until the brightness is where you want it. The system will keep the *same* brightness level at all times; that is, it will not adjust the display brightness to changes in lighting. This may affect viewability in certain lighting situations.

**NOTE:** In low-light settings, the “Fixed” brightness setting may keep the display brighter than is needed for good viewability. Keeping the brightness always at the same level may also use more battery power than necessary.

**Turning the Display On and Off**

1. Open the Motion Dashboard.
2. Tap Off.
3. To turn the display back on, wave your pen over the display or press any key on the keyboard.

**KEEPING TRACK  
OF YOUR  
BATTERY  
POWER**

There are several ways to see how much battery power is left on your Tablet PC:

- **Reading Battery Power from the Tablet PC Display**

To check the power level while you are on battery power, move the pen over the Power/Battery icon, shown here, in the system tray at the bottom-right corner of the Tablet PC display. This displays the number of hours of battery power and the percentage of battery power left. (Also, the blue area on the battery icon shrinks as the battery runs down.)



- **Reading Battery Power from the Battery Gauge**

Turn the Tablet PC over and press the battery gauge button on the battery. Each LED represents about 20% of battery capacity. If all five LEDs are green, the battery is fully charged.

- **Reading Battery Power from Motion Dashboard**

The Motion Dashboard also has a battery power gauge that displays the percent of remaining battery charge.

- **Reading Battery Power from the Power Meter**

- Right-click on the Power/Battery icon in the system tray, located in the lower right-hand corner of the display window (only visible if you are running on the battery). To see remaining power, tap Open Power Meter; or tap Adjust Power Properties>Power Meter tab.
- From the Windows Control Panel (Classic view), double-click Power Options. Or (Category View), double-click Performance and Maintenance, Power Options.

**USING POWER  
SCHEMES**

Your Tablet PC is configured with a default power scheme called “Motion Computing Optimized” that helps improve performance when the Tablet PC is on AC power and battery life when not.



Another preset scheme includes Max Battery mode that puts the Tablet PC in Stand By and Hibernate after a set period of inactivity. When the Tablet PC is running on AC power, this scheme significantly shortens the waiting times for activating these modes, thus conserving battery power.

Other preset power schemes can be found in the Power Options Properties window, including Home/Office Desk, Portable/Laptop, Presentation, Always On, and Minimal Power Management. After you look at these preset schemes, you may want to create additional power schemes for yourself.

**IMPORTANT:** Changing the Power Options Properties settings when a power scheme is selected modifies the selected scheme. If you create a new power scheme, be sure to “Save as” so you do not overwrite a default scheme.

1. From Dashboard, open Power Options Properties. Or, go to the Control Panel and select Power options (Classic view); or (while operating on battery) right-click the Power/Battery to display Adjust Power Properties> Open Power Meter.
2. Tap Adjust Power Properties to open the Power Options Properties.
3. The window opens to the Power Schemes tab.
4. Change the settings to the desired power configuration.
5. Tap Save As and enter a name for the new scheme.
6. Tap Apply.



## CHARGING THE BATTERY

When you connect the Tablet PC to AC power with the battery installed, the system automatically charges the battery until it reaches full charge.

The Battery Status LED is amber while the battery is charging and changes to green when fully charged. If the battery temperature is above the recommended range, the LED turns red. See Table 2-4 for other battery status descriptions.



**WARNING:** To avoid injury, keep the battery within the recommended temperature range when charging it. Wait until it cools to room temperature before recharging it in the Tablet PC or the battery charger. For more information, see the *Safety and Regulatory Guide* shipped with your Tablet PC or the documentation that came with the battery charger. Or go to [www.motioncomputing.com/support](http://www.motioncomputing.com/support) to view these documents.

To charge the battery:

1. Plug the AC power adapter into the Tablet PC, then into a wall outlet or power strip. (Completely recharging the battery may take up to two hours, although the battery reaches an 80% charge in much less time.)
2. Turn the Tablet PC over to see the battery gauge on the bottom of the Tablet PC and press the button next to the battery gauge. If all five LEDs are green, the battery is fully charged. Or, move the pen over the Power/Battery icon to display battery power resources. (The blue area on the battery icon shrinks as the battery runs down. This icon is completely blue when the battery is fully-charged.)



**SWAPPING THE BATTERY**

You can swap the battery while the system is powered on, with or without having the Tablet PC plugged into an AC power outlet.

1. If the Tablet PC is running, save all active files.
2. Go to Start>Turn Off Computer.
3. (On a domain) When the Turn Off Computer window appears, tap Stand By or Hibernate from the drop-down list.  
(Not on a domain) Press the Shift key on your external keyboard or tap Shift on the TIP on-screen keyboard to change the option from Stand By to Hibernate.

**IMPORTANT:** Here are some differences between putting the Tablet PC in Stand By or Hibernate mode to swap the battery:

- If you choose Stand By, the Tablet PC is designed to maintain your system for up to 30 seconds while you swap the battery. However, you may have less than 30 seconds if you are running a number of programs that drain power faster. You should save any data before putting the system in Stand By to swap the battery.
  - If you choose Hibernate, you have unlimited time to swap the battery. Hibernate saves the status of the Tablet PC to your Hard Disk Drive so you can resume operations later.
4. Tap Hibernate or Stand By. The Tablet PC displays that it is “preparing to standby or hibernate.”
  5. Wait until the system shuts down. In Hibernate, all LEDs are off; in Stand By, the Power LED flashes.
  6. Push the battery release latch on the bottom of the Tablet PC to eject the internal battery.
  7. Insert the new battery until you hear the latch click, which ensures the new battery is correctly seated.



**CAUTION:** To avoid damage to the Tablet PC, install only Motion Computing batteries, which are specially designed for the Tablet PC.

**DISPOSING OF USED BATTERIES**

The Tablet PC contains a lithium ion (Li-ion) battery that should be disposed of at a hazardous materials recycling center when it is no longer serviceable. Do not throw it in a waste receptacle where it will be sent to a landfill.

**SAVING BATTERY POWER WITH THE AMBIENT LIGHT SENSOR**

Under certain lighting conditions, when the Ambient Light Sensor is enabled, it may automatically dim the display, thus saving battery power. The power savings depends on a combination of the ALS setting (on the brightness slider) and the ambient light in the environment.

**NOTE:** For optimal battery life benefits and viewability, we recommend that you set the brightness slider to the mid-point or slightly above or below mid-point. If you set the slider higher than this, you lose some of the battery-saving benefits, while gaining minimal improvement in viewability. For more information, see the section “Ambient Light Sensor (ALS)” in this chapter.

**BATTERY AND POWER MANAGEMENT HINTS**

- Use AC power when available to lengthen the battery’s usable life. The battery will charge automatically as you run on AC power, so leave the battery in the Tablet PC while you are working.
- Use AC power when installing software or writing to a CD, and, for best performance, when using a DVD player.
- When using battery power, if you leave the Tablet PC unattended, place the system in Stand By or Hibernate.
- Keep in mind that the display, processor, PC Cards, wireless cards, and accessory drives all draw on the battery, so adjust properties and disable unused accessories and PC Cards when operating on battery power.
- When running on battery, adjust the power mode and display brightness to lower settings to prolong the battery life.
- Turn off all wireless devices when not being used through Dashboard.
- Enable the Ambient Light Sensor (ALS) through Dashboard. See the section “Saving Battery Power with the Ambient Light Sensor.”

**ADDING MEMORY TO IMPROVE SYSTEM PERFORMANCE**

Use only Motion memory modules obtained from Motion Computing to upgrade the factory-installed memory.

**Supported Memory Configuration Upgrades M1400**

Base Memory-Slot A*	Base Upgrade-Slot B*	Total Memory
<b>256MB</b>	256MB	512MB
	512MB	768MB
	1GB	1.2GB
<b>512MB</b>	256MB	768M
	512MB	1GB
	1GB	1.5GB
<b>1GB</b>	256MB	1.2GB
	512MB	1.5GB
	1GB	2GB

**Supported Memory Configuration Upgrades M1400c**

Base Memory-Slot A*	Base Upgrade-Slot B*	Total Memory
<b>256MB</b>	256MB	512MB
	512MB	768MB
<b>512MB</b>	256MB	768M
	512MB	1GB

\*The Motion M1400 and M1400c have the base memory factory-installed in Slot A. If you install/reinstall only a single memory module, always install it in Slot A for best performance.

**NOTE:** For information about the current memory upgrade modules available for your Tablet PC, go to [www.motioncomputing.com/products](http://www.motioncomputing.com/products).



**WARNING:** When performing the following tasks, turn off your Tablet PC, unplug the AC power connection, and remove the battery. Ground yourself by touching a grounded conductive surface, such as a device or appliance with a grounded, three-pronged plug. Avoid touching the pins and leads on the memory module and the internal circuitry of the Tablet PC.

1. After you disconnect power, unscrew the L-shaped cover from the bottom of the Tablet PC.
2. If you are replacing a module, pull the clips on each side of the module to release it. When it pops up, you can easily remove it.
3. Align the pins on the memory module with the receptors on the slot.
4. Gently push the new module into the slot at a 25-degree angle until it is firmly seated; then snap it down into place.
5. Replace the external cover and install the two screws.



## INSTALLING OPTICAL DISC DRIVES

For information about installing your Optical Disc Drive, see the documentation packaged with the drive.

### Optical Disc Drive Software

**CDROM Software** — No special software drivers required to operate as a standard CDROM device

**DVD-ROM/CDRW Software** — Requires CD writing software to write onto a CDR/RW disc for CD authoring. While Windows XP Tablet PC Edition 2005 software includes CD writing features and may be sufficient for your needs, the additional CD writing software (provided with the drive) contains advanced features beyond those offered by Windows XP. In addition, you need to install the DVD software (also provided with the drive) to view video DVDs.

## MIRRORING OR EXTENDING YOUR DISPLAY

The Tablet PC has a Dual Head Video Controller that lets you run a presentation from your Tablet PC on an external monitor or data projector while taking notes in ink. Or, move applications onto a second monitor to create additional work space.

### Connecting the Tablet PC to a Monitor or Projector

1. Plug the VGA monitor cable into the VGA port on the Tablet PC or Motion FlexDock.
2. Connect the external monitor or data projector to a power outlet and turn it on. The software recognizes the external monitor or data projector and searches for a driver.
3. If necessary, install the driver from the CD supplied by the monitor's manufacturer.
4. Set up the mirrored desktop or external display, using the steps in the following sections.

**IMPORTANT:** Be sure to drag any application window back to the Tablet PC display before shutting down the external data projector or monitor. Otherwise, you cannot access the application(s) to shut it down. If you do leave an application open on the extended display, you can disable it from the Windows Control Panel Display Properties or from the Motion Dashboard.

### Setting Up a Mirrored Desktop

Use this feature to connect an external projector for presentations or an extra display on your desk. This example shows (1) a Word document displayed (“mirrored”) on both (2) the Tablet PC and (3) an external monitor.

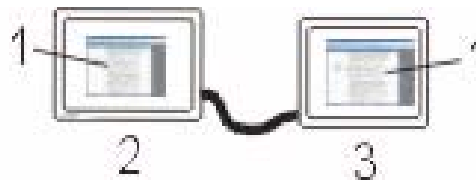

**Mirrored Desktop Example:** (1) Word Document; (2) Tablet PC; (3) External Monitor

**NOTE:** The resolution and orientation of the external monitor will be the same as the Tablet PC display.

- Open the Motion Dashboard.
- Select the Mirror Desktop radio button under External Display. This setting automatically creates an identical display on the external monitor.

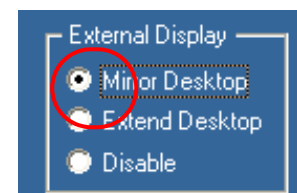

**NOTE:** You can also tap the icon for the Intel(R) Extreme Graphics 2 for mobile, in the system tray at the bottom right of the Tablet PC display (or found in the Windows Control Panel) to set up this feature from the Extreme Graphics pop-up menu.

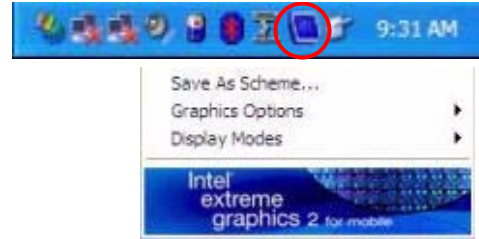

**Setting Up an Extended Desktop**

Use this feature to when you want to simultaneously open an application(s) on two monitors and significantly expand your workspace without hiding open documents under layers of other work. This example shows (1) the Tablet PC and (2) an external monitor with an Excel spreadsheet extended on both. It also shows (4) a Word document on the Tablet PC and (5) e-mail on the extended desktop.

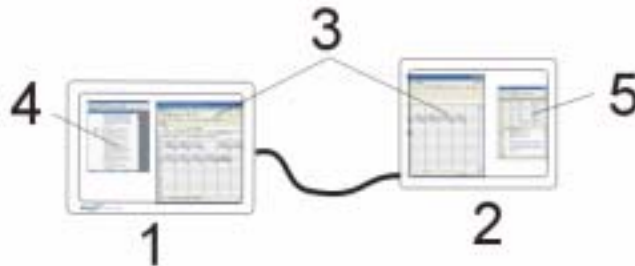

**Extended Desktop Example:** (1) Tablet PC; (2) External Monitor; (3) Spreadsheet; (4) Word Document; (5) Email

1. Open Dashboard.
2. Select the Extend Desktop radio button under External Display. This setting automatically extends the Tablet PC display to the external monitor.

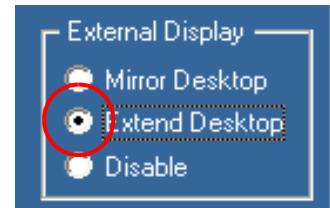

**NOTE:** You can also tap the icon for the Intel(R) Extreme Graphics 2 for mobile in the system tray at the bottom right of the Tablet PC display (or found in the Windows Control Panel) to set up this feature from the Extreme Graphics pop-up menu.

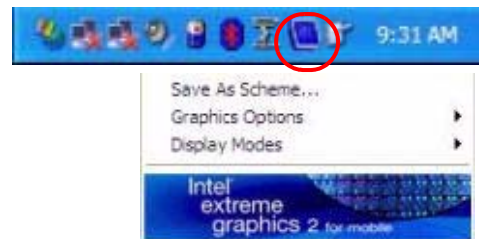

**Hints**

- Use a mouse pointing device and keyboard to operate in these modes.
- The pen does not work in the extended mode.

## CREATING A SCREEN-RESOLUTION SCHEME FOR AN EXTERNAL MONITOR OR SIMILAR DEVICE

To create a special screen resolution scheme:

1. Tap the Properties button under External Display on the Motion Dashboard. Or, tap the Intel(R) Extreme Graphics 2 for mobile icon in the system tray, located at the bottom-right corner of the display; then Graphics Options>Graphics Properties....

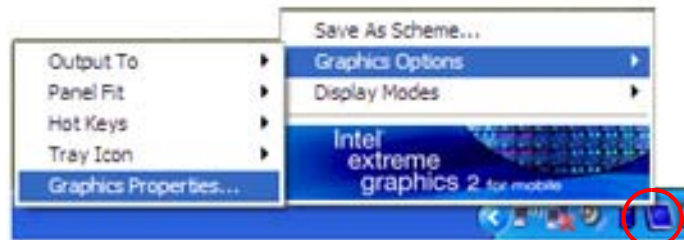

2. From the Intel(R) 82852/82855 GM/GME Graphics Controller Properties window, select the Schemes tab. The current Video Mode is displayed. (The default mode is 1024 x 768 True Color (60 Hz).
3. Tap the New... button on this window.
4. Type in a name for the new scheme. Tap OK to save the scheme.
5. Highlight this new scheme in the Schemes window.
6. Add or change the parameters for this scheme.
7. Tap Save.
8. To test or launch a scheme, select it from the list and tap the Invoke button.
9. Tap OK.

## SETTING UP A WIRELESS CONNECTION

Wireless network access points are available in airports, public businesses, such as coffee shops, as well as in private companies. With the proper hardware, you can set up a wireless access point at home. Each access point may provide various levels of security and may require passwords and/or fees for connection.

**IMPORTANT:** Since wireless set ups differ widely, the information presented here is general and may not cover all the steps required for your wireless configuration. For more information about wireless networks, you may need to contact your System Administrator. Or, go to Start>Help and Support and search for wireless help from Microsoft.

Although wireless access is available in public areas, your ability to use the wireless access point depends on the following conditions:

- Distance from the access point
- Ability to connect to the access point
- Service rights to it (which may require an account fee, user name, password, an/or network setup through an administrator)
- The access point is not broadcasting a network name (SSID: service set identifier)



**WARNING:** FAA regulations require that you disable any wireless connection when traveling by air. If the Wireless LED on the front of the Tablet PC is off, *internal* wireless communications are disabled.

To set up a wireless connection through the Motion Dashboard:

**NOTE:** The Tablet PC antenna should not be covered by your hand when making a wireless connection.

1. Open the Motion Dashboard and make sure that Enable 802.11 Wireless Radio is checked.
2. Under Wireless Operation, tap Properties.
3. On the Wireless Network Connection Properties screen, tap the Wireless Networks tab.
4. Tap View Wireless Networks to see a list of available networks

**NOTE:** Some wireless networks may not appear on the list. To show all wireless networks, tap Show wireless access point names.

5. Highlight the network you want to connect to and tap Connect.
6. Tap OK.

**NOTE:** To complete the wireless connection, you may need to download additional files to enable the connection. You may also be required to enter a network key.

To set up a wireless connection through the Control Panel:

1. Open the Control Panel and tap Network Connections.
2. Make sure the Wireless Network Connection is enabled. (If it is not, right-click on the connection and tap Enable.)
3. Right-click Wireless Network Connection tab.
4. Repeat Steps 4-7 in the previous procedure.

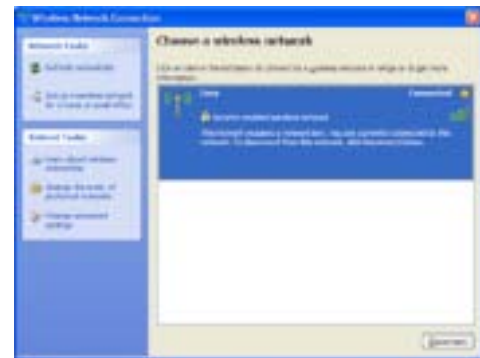
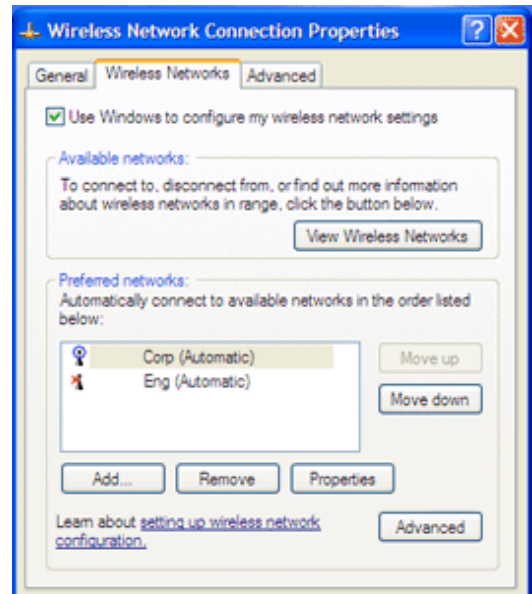

## Network Management Tools For Advanced Users

For advanced users who want additional network management tools, Motion provides the Intel PROSet for Wireless utility with the software image. If you have an Intel wireless card installed, the PROSet utility lets you create profiles automatically to suit your specific connection requirements. It also provides statistics such as signal strength, signal quality, and throughput, and creates statistical logs for the adapter and the connection.

**NOTE:** PROSet does not work with Broadcom wireless cards. To see what wireless card you have installed, go to Start>My Computer>View system information. On the System Manager Hardware tab, tap Device Manager. The wireless card is listed under Network adapters.

To install Intel PROSet for Wireless, go to the c:\windows\motion>iWlan directory and tap autorun. This starts the Intel PROSet for Wireless InstallShield Wizard. Once PROSet is installed, you can access it through the icon in the system tray or from Start>All Programs>Intel Network Adapters>Intel(R) PROSet for Wireless.

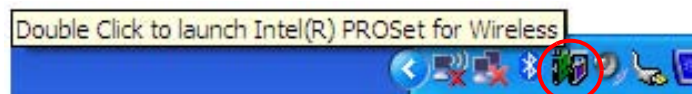

The iWlan>PROW2200>DOCS directory also contains the user guide for this utility.

### BLUETOOTH TECHNOLOGY

Bluetooth cable-replacement technology allows devices to connect and exchange information wirelessly. Unlike proprietary wireless technologies found in many of today's wireless products, Bluetooth offers a published protocol that supports a much wider variety of devices and is considered one of the most robust and versatile wireless technologies available.

Unlike Infrared Data Association (IrDA) devices, which must have a direct line-of-sight connection to operate, Bluetooth devices are radio frequency (RF) devices operating at 2.4GHz at a range of up to 10 meters (33 feet) and through solid, non-metal objects. Furthermore, Bluetooth requires minimal power and uses frequency hopping and key pairing for security. Using the Bluetooth protocol, a Bluetooth-enabled device can connect and exchange information with another Bluetooth-enabled device including keyboards, mice, printers, bar code scanners, cellular phones, PDAs, Tablet PCs, notebook PCs, and more.

### BLUETOOTH AND YOUR MOTION TABLET PC

Built into your Motion M1400 Tablet PC is a Bluetooth wireless radio, part of an emerging technology of products designed to eliminate cables through a low-powered, short-distance personal area network.

Motion Computing and its Bluetooth partners have worked to ensure a positive experience with this technology, as well as to ensure Bluetooth interoperability. In doing so, the following operating issues have been found:

- When simultaneously operating Bluetooth wireless and 802.11 wireless, interference between these wireless technologies impacts Bluetooth performance. This is most noticeable when you try to transfer large amounts of data, such as file transfers or printing large documents. This may also be noticeable when you try to transfer large or small amounts of data may if several Bluetooth devices are operating simultaneously in an office.
- Bluetooth audio support is currently based on technology that has not been fully developed for speech recognition. In addition, the Microsoft Bluetooth software in the Tablet PC does not have a pre-installed Bluetooth headset *profile*. Therefore, for speech recognition, we recommend that you not use a Bluetooth wireless headset. Moreover, the Motion Speak Anywhere technology is designed to record clear audio, dictate notes, and use voice commands without the need for *any* type of microphone headset.
- Should you attempt to install other wireless headset or other audio drivers (such as Bluetooth or USB) over the Tablet PC audio drivers, a malfunction of the Tablet PC audio system may occur because the drivers may not be compatible.
- Because Bluetooth is a relatively new technology, some cross-device compatibility issues may occur. If you are having problems with interoperability of Bluetooth devices, contact the manufacturer of your Bluetooth device and check its compatibility with the Bluetooth software installed on your Tablet PC.
- Do not install Bluetooth software from another manufacturer over the Microsoft Bluetooth software installed on the M1400. This will cause malfunction of the M1400 Bluetooth system.

#### MICROSOFT BLUETOOTH SOFTWARE

The Microsoft Bluetooth software is installed and ready for use in connecting external Bluetooth devices, such as keyboards, or mice with your Tablet PC. No other Bluetooth software is needed. (However, other Bluetooth devices (such as printers) may require additional device drivers. (See the documentation that came with the device for more information.)

#### BLUETOOTH WIRELESS RADIO

As soon as you turn on your Tablet PC, the wireless LED begins flashing, indicating that it is sending wireless signals for Bluetooth as well as for 802.11:

- Bluetooth wireless radio — LED flashes blue
- 802.11 Wi-Fi wireless — LED flashes green

The internal Bluetooth wireless radio in the Tablet PC is enabled by default. This setting is found on the Motion Dashboard.



## BLUETOOTH DEVICES ICON

When you first turn on your Tablet PC, you will see a Bluetooth Devices icon in the system tray.



This icon offers shortcuts to the Bluetooth Devices window, the Add Bluetooth Device Wizard, and the Bluetooth File Transfer Wizard.

**NOTE:** If your Bluetooth Devices icon does not appear in the system tray, you can add it by going to Start>Control Panel and tapping the Bluetooth Devices icon. When the Bluetooth Devices window appears, tap the Options tab and place a checkmark beside Show the Bluetooth icon in the notification area.



**OVERVIEW  
OF THE  
BLUETOOTH  
DEVICE  
CONNECTION  
PROCEDURES**

The following procedures are common for connecting all Bluetooth devices (keyboard, mouse, printer, cellular phone, PDA, Tablet PC, notebook PC, etc.). The actual steps are slightly different for every type and brand of Bluetooth device.

**IMPORTANT:** Read these general procedures before starting to set up your Bluetooth device. Then go to the specific section for connecting a keyboard, mouse, and transferring files.

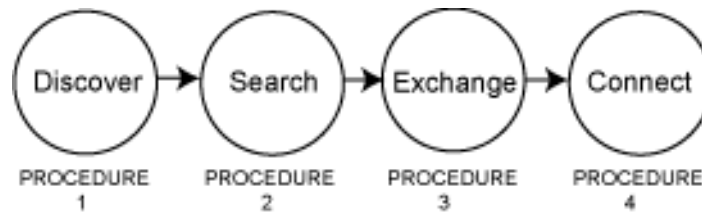
**PROCEDURE 1: Make the device discoverable**

Making a Bluetooth device discoverable makes it visible to other Bluetooth devices. The Bluetooth device will broadcast a signal with information about itself and indicate it is available for connection. Each Bluetooth device uses a different method (pressing a button or key combination) to make it discoverable; this is generally described in the device's documentation. Tablet PCs are made discoverable through the Bluetooth Devices window, Option tab; they are not discoverable by default.

**PROCEDURE 2: Search for Bluetooth devices in range**

This process will find every Bluetooth device *that is discoverable and available for connection* within 33 feet (10 meters).

**PROCEDURE 3: Exchange a passkey**

Exchanging a passkey creates a connection between the Tablet PC and Bluetooth device using a unique eight-digit number. This passkey prevents data from being intercepted by another device. For example, if two people have desks next to each other and each wants to use a Bluetooth keyboard, they can do so without interference because each Tablet PC and keyboard shares a different passkey.

**IMPORTANT:** The passkey exchange helps to secure your data. However, it can be compromised or fail, and, if that happens, your data could be visible or accessible by other devices or computers within range. Therefore, Bluetooth wireless technology should not be considered completely secure.

**PROCEDURE 4. Connect the devices**

The first time a Bluetooth device is connected to the Tablet PC the drivers are loaded for that device. After this initial connection, some Bluetooth devices may disconnect when they go into power saving mode. Most will automatically reconnect when they become active again.

## USING THE BLUETOOTH DEVICE WIZARD TO CONNECT A BLUETOOTH DEVICE (BLUETOOTH KEYBOARD EXAMPLE)

In this section, the Bluetooth Device Wizard is used to connect and exchange passkeys between a Bluetooth keyboard and the Tablet PC. This is a general example only; some of the steps may be slightly different for other devices.

**IMPORTANT:** Follow these steps before installing any software that came with your Bluetooth device. You may need to install application software for your device at the end of this procedure, *but do not install any new Bluetooth software before you complete the Device Wizard.*

### 1. Start the Bluetooth application

a. Make sure that either the Bluetooth LED is flashing or that there is a checkmark beside Enable Bluetooth Wireless radio (both indicate that Bluetooth is running) in the Motion Dashboard.

b. Using your pen, single tap the Bluetooth Devices icon in the system tray.

c. Tap Add a Bluetooth Device to launch the Bluetooth Devices application window.

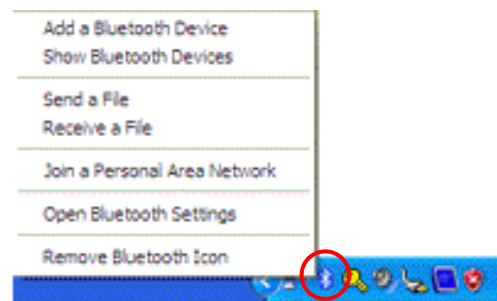

The Add Bluetooth Device Wizard appears.



### 2. Make the device discoverable

a. Before starting the Add Bluetooth Device Wizard, place the Bluetooth device (mouse, keyboard, printer, etc.) in discoverable mode. This sends a signal that is detected by the Bluetooth card in the Tablet PC.

**NOTE:** Each Bluetooth device may have a different way to make it discoverable. Some have a small button on the back of the mouse or keyboard; others may require that you press a key sequence on the keyboard. Look at the documentation that came with the Bluetooth device or visit the manufacturer's website for information.

b. After you make the Bluetooth device discoverable, place a checkbox beside “My device is set up and ready to be found.”

c. Tap Next.



### 3. Add the Bluetooth device

a. The Add Bluetooth Device Wizard begins searching for Bluetooth devices within range.

**NOTE:** If the system does not find the Bluetooth device in a short time, tap Back, reset the device (to make it discoverable) and tap Search Again.

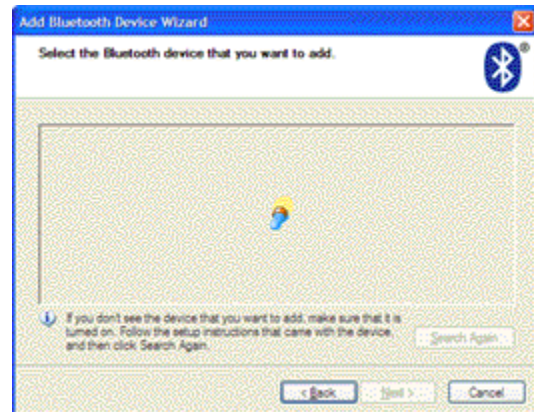

b. When the icon for your Bluetooth device appears in the Select a Bluetooth device you want to add window, highlight the device.

c. Tap Next.

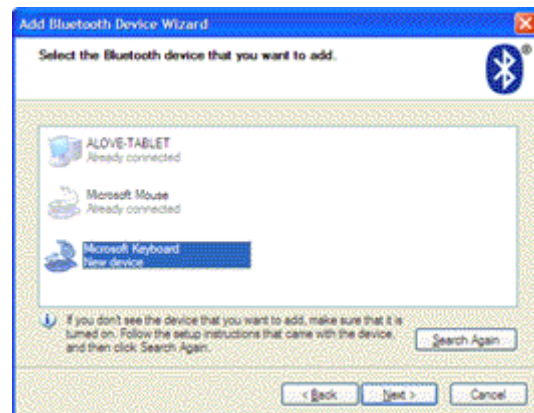

**NOTE:** The Tablet PC may discover other Bluetooth devices and display them in this window, as shown in this example.

#### 4. Start the passkey exchange process

a. When the “Do you need a passkey to add your device?” selection window appears, you have several options.

For this example, place a checkmark beside Choose a passkey for me. This option lets Windows automatically provide a passkey. You can also select another option, depending on whether your device comes with a passkey or if you want to select a passkey yourself.

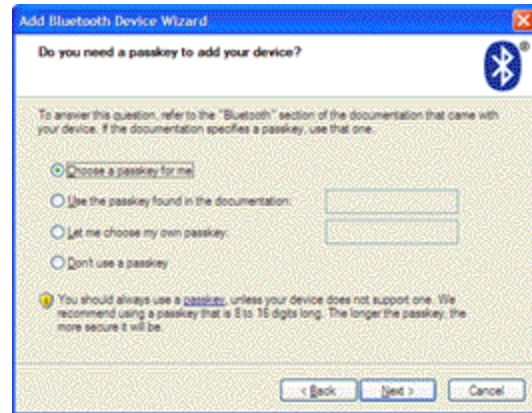

b. Tap Next. The Wizard will display a message that it is connecting and then the passkey number.

c. Using your Bluetooth keyboard, immediately type the eight-digit number shown in the Passkey field.

d. Press the Enter key on the Bluetooth keyboard. If the passkey has been detected, a checkmark appears beside “Connecting” and the Bluetooth software begins installing.

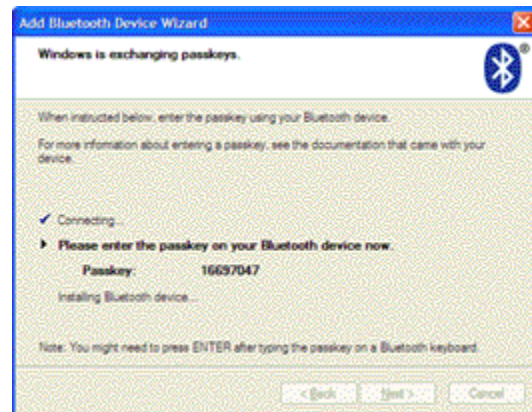

It may take a short time to complete the connection. Please wait.

**NOTES:** A message may appear that Windows has been unable to exchange passkeys with the Bluetooth device and a passkey exchange failure has occurred. You might have entered an incorrect passkey or taken too much time to enter the passkey. Tap the Back button and try entering the passkey again.

#### 8. Tap finish to complete the installation

When the Completing the Add Bluetooth Device Wizard window appears, the Bluetooth installation is complete.

#### 9. Take your device for a spin

You can now begin using your Bluetooth device.

**IMPORTANT STEPS TO TAKE IF THE DEVICE IS NOT DISCOVERED**

If the Tablet PC fails to detect the Bluetooth device after what you consider a reasonable number of attempts, try the following:

- Make sure the Bluetooth LED is flashing. If not, open the Motion Dashboard and enable the Bluetooth Wireless radio button.
- Make sure the device you are adding is discoverable. There are several things you need to check:
  - Install new or fully charged batteries in the Bluetooth device; make sure these are installed correctly
  - For keyboards, mice, printers, etc., read the instructions that came with the device or visit the device manufacturer's website for information and other troubleshooting tips. Some devices have a button to press or a series of keys to press to make it discoverable.
  - Also with keyboards, mice, printers, etc., be sure that when you go through the Add Bluetooth Device Wizard that you place a checkmark beside "My device is set up and ready to be found."
  - For Tablet PCs transferring files, both Tablet PCs must turn on the device transfer wizard, although only the receiving Tablet PC needs to be discoverable. Tap the Bluetooth icon and then either "Send a file" or "Receive a file." When you do this, discovery is automatically turned on for the *receiving* device (see Steps 2a and 2b in the section "Transferring and Receiving Files Over Bluetooth" in this chapter).
  - Also for Tablet PCs, you need to enable "Allow Bluetooth devices to connect to this computer" to connect to keyboards, mice, printers, etc. While this is the default, make sure that this setting has not been changed. You find this by right-clicking the Bluetooth icon>Show Bluetooth Devices>Options.
- When you open the Bluetooth Devices tab, only the connected devices will be displayed. Other devices are only displayed when you add a device using the Bluetooth Device Wizard.
- Check to see what Bluetooth devices are connected. Tap the Bluetooth Devices icon>Open the Bluetooth Settings. On the Devices window, you should be able to see Bluetooth devices that are currently connected.

If the Bluetooth card in the Tablet PC still fails to detect the Bluetooth device, contact the device manufacturer or visit their website for assistance.

## SET UP A DEVICE (BLUETOOTH MOUSE)

**IMPORTANT:** When installing Bluetooth devices, follow the steps in this procedure before installing any software that came with the device. You may need to install application software for the device at the end of this procedure and should be prompted when this is necessary. However, do not install new Bluetooth software for your Tablet PC.

### Pre-Installation Step: Check the batteries

Before you begin the Bluetooth mouse installation, install new or fully-charged batteries in the Bluetooth mouse.

### 1. Start the Bluetooth Application

- Make sure that either the Bluetooth LED is flashing or that there is a checkmark beside Enable Bluetooth Wireless radio (both indicate that Bluetooth is running) in the Motion Dashboard.
- Single tap the Bluetooth Devices icon in the system tray.
- From the pop-up menu, select Add a Bluetooth Device.

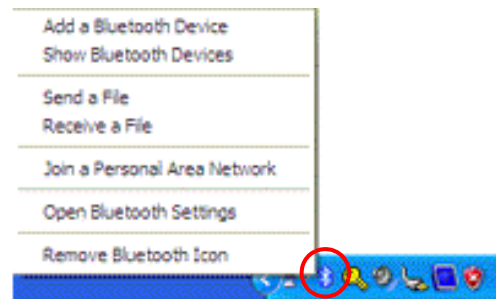

The Add Bluetooth Device Wizard -Welcome window appears.



### 2. Make the mouse discoverable

- Before starting the Add Bluetooth Device Wizard, place the Bluetooth mouse in discoverable mode. This sends a signal that is detected by the Bluetooth card in the Tablet PC.

**NOTE:** Each Bluetooth mouse may have a different way to make it discoverable. Some have a small "Connect" button on the back of the mouse. Look at the documentation that came with the Bluetooth device or visit the manufacturer's website for information.

b. On the Welcome window, place a checkmark beside “My device is set up and ready to be found.”

c. Tap Next.



### 3. Add the Bluetooth mouse

a. The Add Bluetooth Device Wizard begins searching for the Bluetooth mouse.

**NOTE:** If the system does not find the Bluetooth mouse in a short time, tap Back, reset the Mouse (to make it discoverable) and tap Search Again.

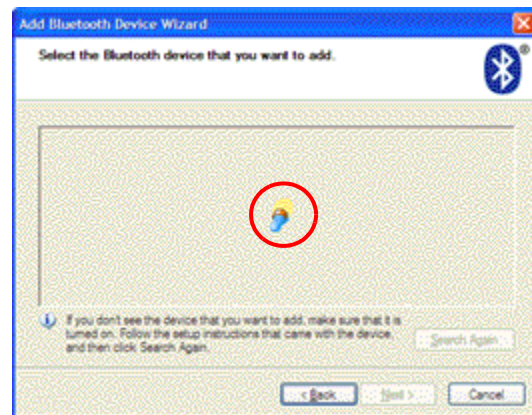

b. When the icon for the Bluetooth mouse appears in the Select a Bluetooth device you want to add window, highlight it.

c. Tap Next.

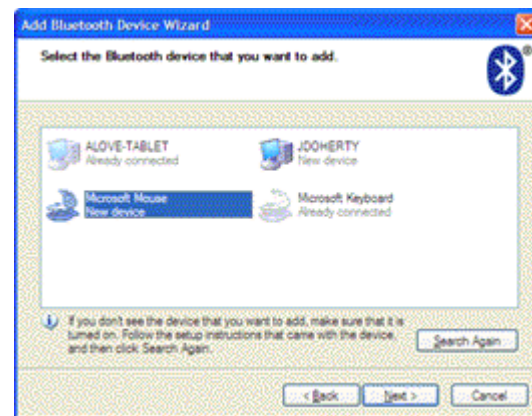

**NOTE:** The Tablet PC may discover other Bluetooth devices and display them in this window, as shown in this example.

#### 4. Select the “Don’t use a passkey” option

a. When the “Do you need a passkey to add your device?” window appears, tap “Don’t use a passkey.”

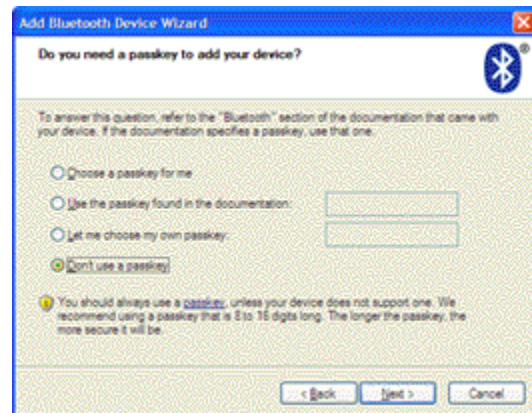

b. Tap Next.

The system connects and begins installing the Bluetooth mouse device drivers.

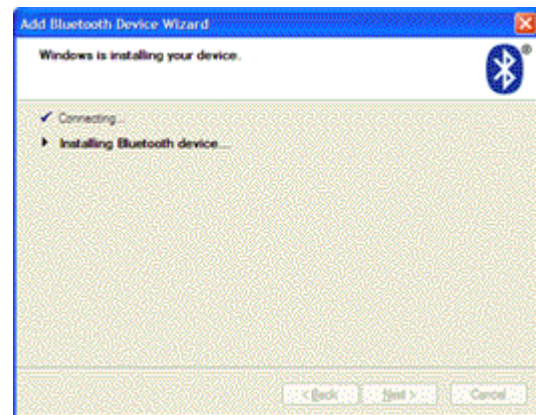

#### 5. Tap Finish to complete the installation

When the drivers are installed, tap Finish to complete the installation.

**NOTE:** A system reboot is not required.

The Bluetooth mouse is ready to use. If you look at the Bluetooth Devices window, the Bluetooth mouse is now displayed.

**NOTE:** During a period of inactivity, the Bluetooth mouse will go into a power-saving mode. Simply moving the Bluetooth mouse should reactivate it. If it does not reactivate, you may need to Remove and Add the mouse.

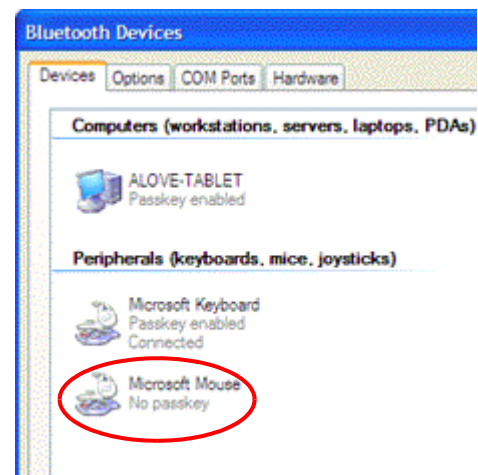

## TRANSFERRING AND RECEIVING FILES OVER BLUETOOTH

You can transfer and receive a file from one Tablet PC to another using Bluetooth wireless technology. Unlike some file transfers, the Tablet PC *receiving* the file must be set up to receive the file and both Tablet PCs must be running the Bluetooth File Transfer Wizard for the transfer to occur.

The following steps describe how this is done.

### Pre-installation step: set up a passkey

Before you begin the transfer, choose a passkey (of 8-16 characters; the longer the passkey, the more secure it will be) with the person receiving the files. Microsoft recommends setting up and using a passkey (unless the device does not support one), which provides a secure link between the Tablet PCs and helps prevent others from viewing the files. Step 3d of this procedure describes the use of the passkey.

### 1. Open the Bluetooth File Transfer Wizard

On the sending and receiving Tablet PCs, single tap the Bluetooth Devices icon. A Bluetooth pop-up menu appears.

**NOTE:** Double-clicking will open the Bluetooth Devices window.

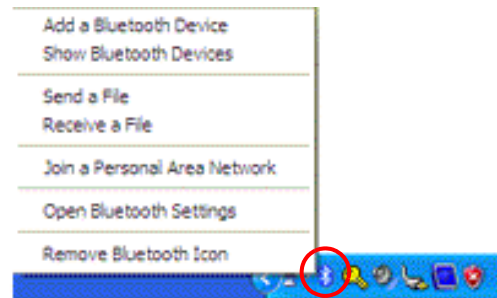

Alternately, you can go to Start>All Programs>Accessories>Communications>Bluetooth File Transfer Wizard.

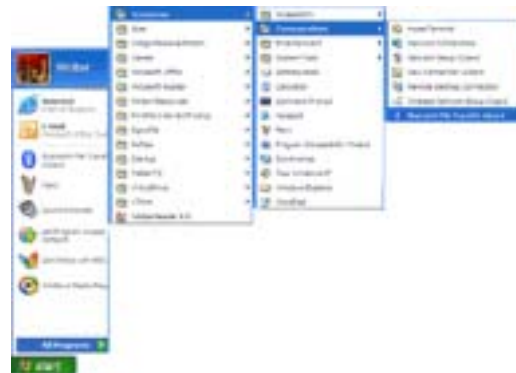

## 2. Select whether to send or receive a file

### *On the Sending Tablet PC:*

- Select Send a file.
- Tap Next.
- Go to Step 3.

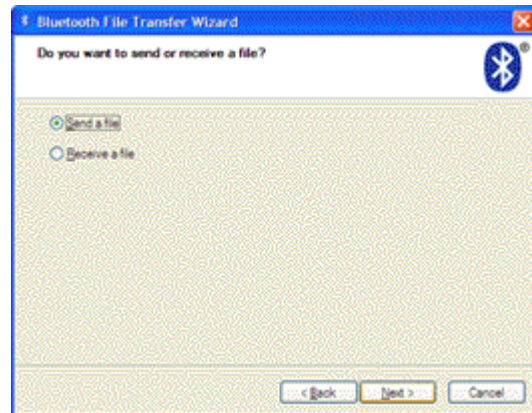

### *Receiving Tablet PC:*

- Select Receive a file.

**IMPORTANT:** Discovery on the *receiving* Tablet PC is automatically turned on when you tap Receive a File.

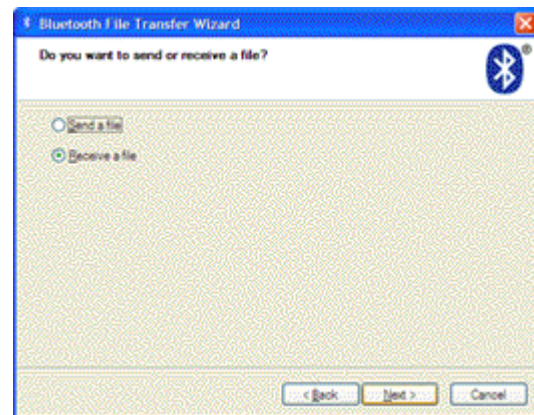

- Tap Next. As soon as you do, the receiving Tablet PC indicates that it is waiting for a connection to another Bluetooth device.

- Skip Steps 3 and 4 and go to Step 5.

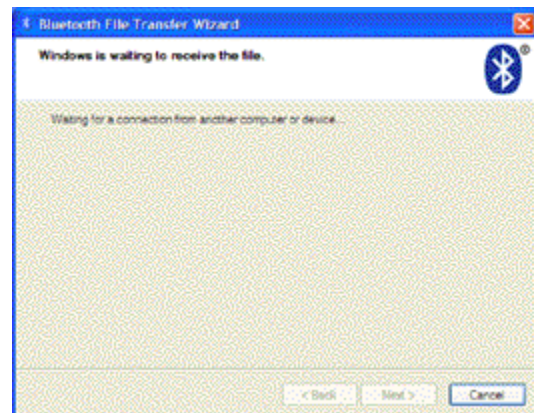

### 3. From the sending Tablet PC, select where you want the file to go (Tablet PC)

a. Tap the Browse button. Bluetooth will search for a device (Tablet PC) and display all Bluetooth devices that are within range and that are discoverable.

b. Highlight the Tablet PC you want to send a file to.

c. Tap OK. The device will be displayed in the Send to area.

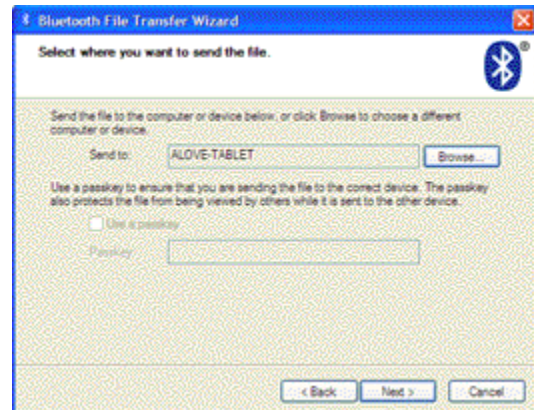

d. Place a checkmark beside “Use a passkey.”

**NOTE:** If you have previously set up a passkey with this device, this option is grayed out.

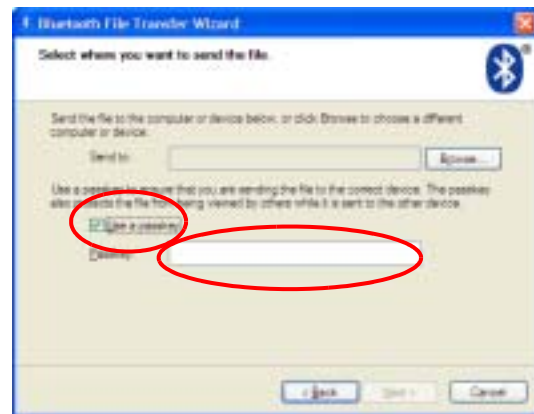

e. Enter the passkey that you have set this up with the person receiving the files. They must also enter this number on their Tablet PC.

f. Tap Next.

**IMPORTANT:** Once you set up a passkey between Tablet PCs, you can transfer files between them without re-entering this number. The link between them will remain secure until you remove both of the devices from the Bluetooth Devices window. As noted earlier, this option will be grayed out if a passkey has been set up.

#### 4. From the sending Tablet PC, choose a file to send

- Select the Browse button and find the file you want to send.
- Tap Next.

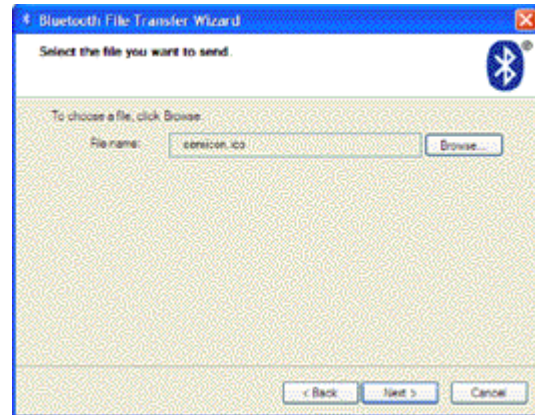

The first time you transfer files, the connection between the two devices is authenticated.

Then the connection is made.

**NOTE:** Authentication occurs the first time you connect using a Passkey. Once you authenticate the connection, this message does not appear.

The file transfer progress is displayed.

Depending on the size of the file, the transfer may take some time. Wait until the transfer is complete.

**NOTE:** Files are transferred and received at approximately the same rate.

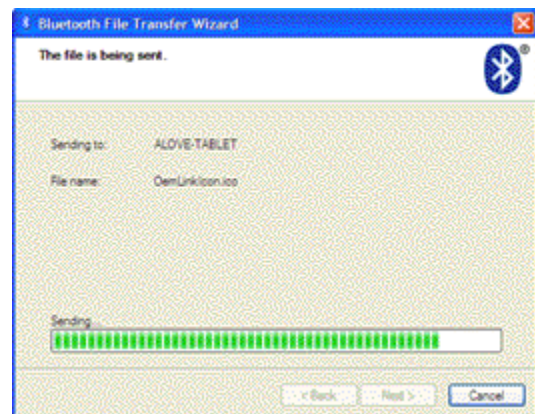
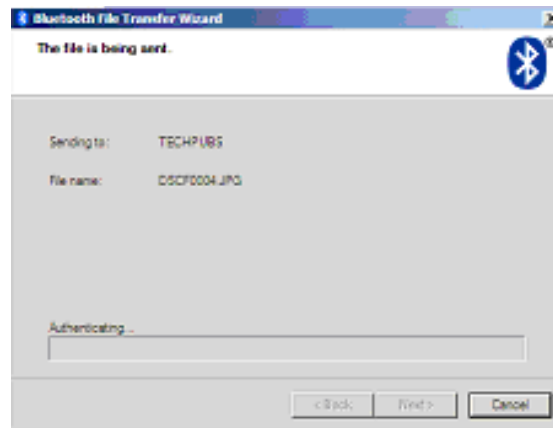

#### 5. On the receiving Tablet PC, wait for the connection and for the file to transfer

- This pop-up message appears the first time the sending device tries to connect to your Tablet PC. Tap on the message to start the connection.

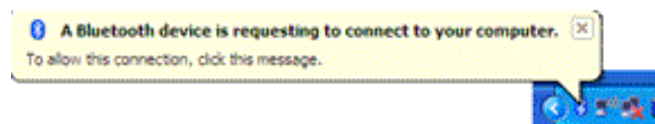

**NOTE:** Once you establish a connection between Tablet PCs, this message will not be displayed.

b. On this screen, leave the option “Turn discovery off” checked (the default). This means that your Tablet PC will not be visible to other Bluetooth devices when the file transfer is complete.

**IMPORTANT:** Discovery was automatically turned on when you select Receive a File (see Step 3 of this procedure).

c. Tap Finish.

d. Enter the passkey you have set up with the other Tablet PC user.

e. Tap Next.

The progress of the transfer is displayed. Depending on the size of the file, this may take some time.

**NOTE:** The files are sent and received at approximately the same rate.

f. Skip Step 6 and go to Step 7.

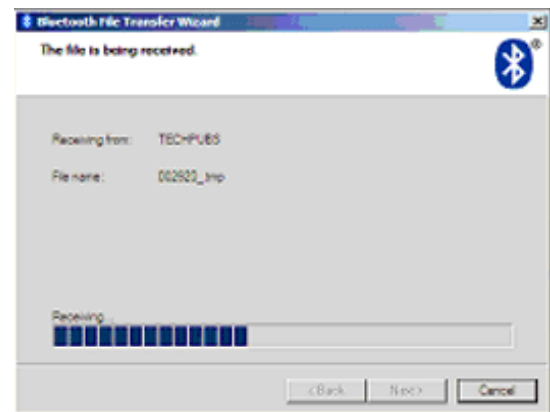
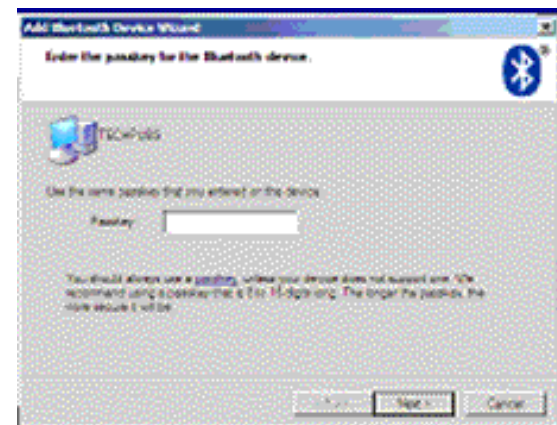
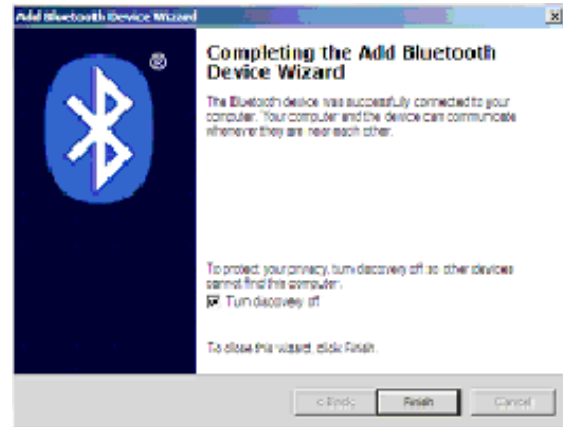

## 6. On the sending Tablet PC, complete the transfer

a. The sending Tablet PC displays the destination (Sent To) and File Name.

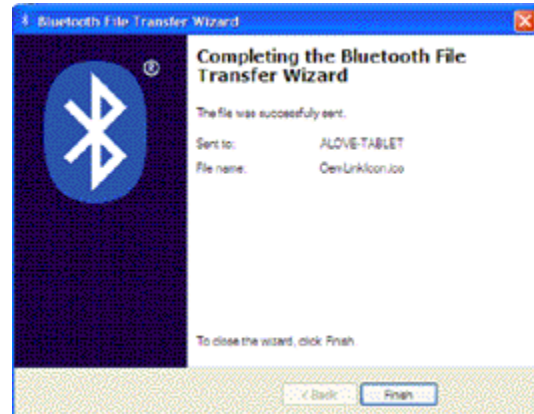

b. Tap Finish to complete the transfer.

The transfer is complete for the sending Tablet PC.

## 7. On the receiving Tablet PC, complete the transfer

When the file has been transferred, the name of the transferred file is displayed along with a default location where the file will be saved.

a. Browse to the location where you want to save the file.

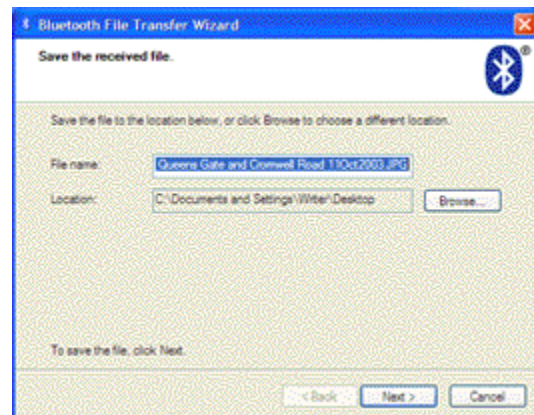

b. Tap Next to save the file.

c. Tap Finish after the file has been saved.

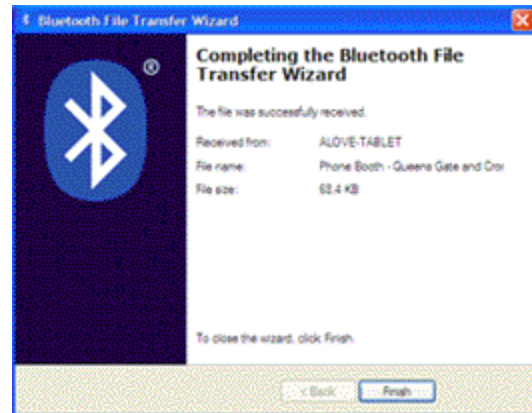

The transfer is complete to the receiving Tablet PC.

### Removing a Device from the Bluetooth Device List

After you establish a connection between Tablet PCs for file transfers, the Use a passkey option will be grayed out (not available) when you begin the file transfer.

In addition, the device will be displayed as the default device in the Send to list when you open this window.

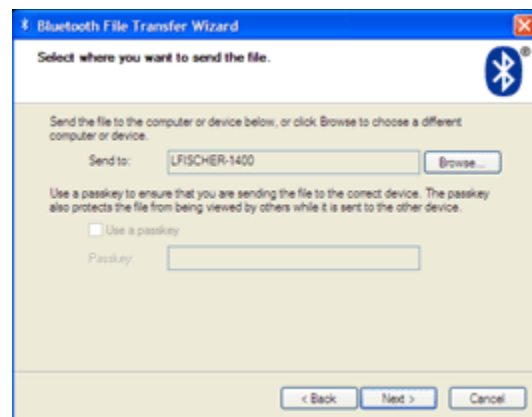

The Bluetooth Device list also indicates that the device is “Already connected.”

To remove this connection so these Tablet PCs are not visible to each other:

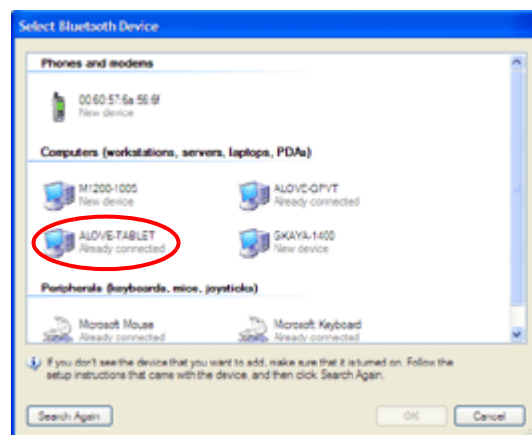

1. Single tap the Bluetooth icon in the system tray.
2. From the menu, select Open Bluetooth Settings.
3. From the Options tab of the Bluetooth Devices window, highlight the device you want to disconnect.
4. Tap Remove.

**NOTE:** You must perform this procedure on both of the connected Tablet PCs. Once disconnected, the Use a passkey option will be available (not grayed out) and this Tablet PC will not appear in the Bluetooth Devices list.

**SPEAK  
ANYWHERE  
TECHNOLOGY  
OVERVIEW**

The Motion Speak Anywhere™ audio system combines the Knowles® Acoustics IntelliSonic™ software application with two integrated microphones to let you record clear audio, dictate notes, and use voice commands without the need for a microphone headset. These capabilities make the Motion Tablet PC with Speak Anywhere technology a valuable tool for mobile users in a variety of work settings, including small or large groups, or for individual dictation or voice commands.

**Motion Speak Anywhere™ Technology Components**

- Dual, integrated, microphones — The integrated microphones help optimize the sound capturing capabilities of the Tablet PC for speech recognition and voice recording. The locations of the microphones have been carefully designed to let the system detect sound input from a specific angle, rejecting sounds from outside that angle.
- Knowles Acoustics IntelliSonic software — This software lets you direct sounds coming from a specific direction to the microphones, while canceling interfering noise from other directions, thus minimizing the effects of environmental noise and eliminating acoustic echo feedback. It is based on the following audio technologies:
  - Array Processing or “beam forming” software — Removes all sound outside a software-defined “angle of acceptance”
  - Noise Supression — Removes background and ambient noise
  - Acoustic Echo Cancellation (AEC) — Removes echo caused by the microphone picking up the system’s speaker output, thus preventing feedback

Motion Speak Anywhere technology provides integrated controls for:

- Speech recognition, including dictation and voice commands — Available through the TIP window
- Audio recording and playback — Available through the Microsoft Sound Recorder or a third-party audio application, such as Microsoft Office OneNote™ 2003 (optional with Motion Pak software)

**Microsoft Speech Recognition Software**

Accessed through the TIP interface, this Microsoft utility is the built-in speech recognition resource for the Tablet PC that converts spoken words into typed text or voice commands.

- Dictation mode — Changes everything you say to text; use to enter text directly into any document or text box when you do not want to use the pen or keyboard
- Voice command mode — Listens for specific words that correspond to an existing list of available voice commands; use to quickly switch between programs, for saving documents, etc.

For information about setting up speech recognition, see “Setting Up Speech Recognition” in this chapter. You can also tap Help on the TIP window and search for “speech.”

### Microsoft Sound Recorder

For general recording and playback, the Microsoft Sound Recorder is part of the Window XP Tablet PC Edition 2005 operating system. This sound recorder lets you record, mix, play, and edit sounds, and link or insert sounds into other documents. For information about setting up the Sound Recorder, see “Setting Up the Sound Recorder” in this chapter.

**NOTE:** Many third-party audio applications are available for recording and playback, including Microsoft Office OneNote 2003, which is included with the optional Motion Pak software image.

### AUDIO SYSTEM CONTROLS

The Motion Dashboard contains volume and directional controls for both speech recognition and recording.

#### Volume Controls

- **Speaker volume.** While the noise suppression software removes most background noise, in some cases speaker playback (such as background music or intermittent audio messages) can affect recording. In general, reducing speaker volume will eliminate these extraneous noises.
- **Microphone volume.** The default volume setting for the microphones is at roughly two-thirds of the sliding scale. When recording, dictating, or using voice commands, you may need to adjust this setting.



#### Directional Controls

- **Angle of acceptance.** Three pre-defined “angles of acceptance” are part of the Motion Speak Anywhere audio technology:
  - **Narrow Angle** — Best setting for dictation, Voice over IP, “voice noisy” environments; the microphones detect sound on a narrow angle near the center of the display. If you do not speak within the angle of acceptance, e.g., if you turn your head while dictating or change the angle of the Tablet PC, the sound will not be recorded.
  - **Medium Angle (default)** — Best setting for a small group, conference table, “voice quiet” environment; microphones detect at a wider angle
  - **Wide Angle** — Widest angle of acceptance. Try starting with this setting (even for dictation) before a more restricted angle, which will

capture sound from a large area while still providing noise suppression. Change to the Narrow or Wide Angle to restrict more background noise.

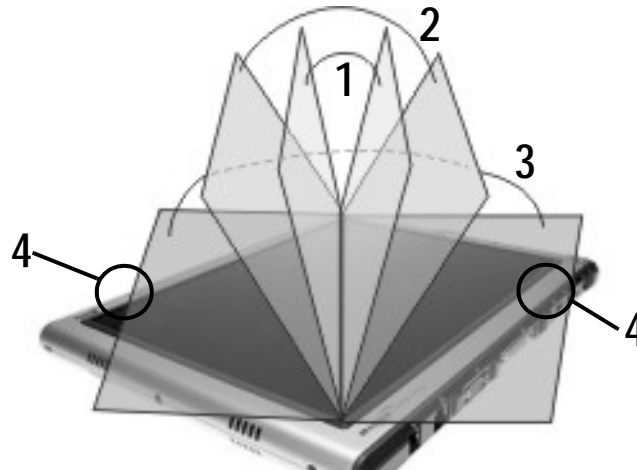

1 Narrow Angle; 2 Medium Angle; 3 Wide Angle; 4 Speakers

- **Skew angle.** The pre-set sound detection area is straight in front of the system display. If you want the system to receive sound from elsewhere, you can skew the receiving direction towards one or the other microphone (keeping the same relative angle of acceptance).



1 Left Skew Angle with Narrow Angle of Acceptance; 2 Right Skew Angle with Narrow Angle of Acceptance

To set up the skew angle:

1. Open the Motion Dashboard.
2. Under Microphone, tap Narrow Angle or Wide Angle.
3. Move to where you want the microphone to detect your voice.
4. Tap Calibrate. A block of text appears.
5. Read the text aloud, speaking normally towards the Tablet PC microphones. This should take 20-40 seconds.

**NOTE:** In many cases, you will not need to calibrate the microphone because the audio system filters out many unwanted sounds. If you are dictating in an office or recording during a meeting, the audio system may work well with no additional calibration.

**IMPORTANT:** The audio system does not store calibrations. If you change to another angle/position and then return to the previous one, you must re-calibrate the audio system.

## SETTING UP SPEECH RECOGNITION

Speech recognition lets you convert spoken words into typed text or into voice commands, letting you use speech to correct errors, format text, or control programs. This is sometimes quicker than typing or writing text.

Before you can use the speech recognizer, you must first adjust it for your voice, pronunciation, speaking pace, and inflection. These adjustments are made through the Speech utility on the TIP window.

### Activating the Speech Recognizer

1. Open the Motion Dashboard and make sure the speakers and microphone are turned on (the default settings).
2. Check that the Speaker Volume and microphone sound levels on the Dashboard are appropriate for your setting.
3. Tap the TIP icon on the menu bar at the bottom of the Tablet PC display. The Tablet PC Input Panel appears.
4. Tap the down-arrow beside Tools to open the Tools options.
5. Tap Speech. The first time you access this function, a Speech Recognition Enrollment message appears. You must adjust the microphone and train speech recognition before continuing. Until you complete speech training, the speech button is inactive. This takes about 10 minutes.
6. Tap Next and follow the Microphone Wizard.

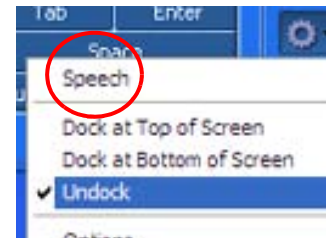

**NOTE:** To improve speech recognition, run additional speech training sessions.

### Setting Up Dictation or Voice Commands

Once you activate speech recognition, depending on your work setting (single-person office or small or large meeting) and what you plan to do (dictate, use voice commands), you may want to change the microphone angle from Medium (the default) to either Narrow or Wide. You may then also want to calibrate the direction of the microphones.

7. Open the Motion Dashboard and select the desired angle.
8. (Optional) To use either Medium or Narrow Angle to dictate from a direction other than directly in front of the display, tap Calibrate and read through the calibration script.

**NOTE:** Calibration will skew the angle at which the microphones detect your voice while keeping the same relative angle of acceptance.

9. To start the Speech recognizer, open the TIP window.
10. Select Dictation (to convert spoken words into typed text) or Commands (to use your voice to enter commands, such as “Enter,” “Save,” “Open”).

**NOTE:** For more information about using this feature and for available voice commands, see the Windows Help and Support Center where you can search for topics about speech recognition and training. Also available are the speech tutorials. To find the speech tutorials, select Start>Help; then Support>Welcome to Tablet PC>Tablet PC Tutorials.

## SETTING UP THE SOUND RECORDER

The Microsoft Sound Recorder is a general-purpose audio device for recording and playback.

1. Open the Motion Dashboard and make sure the speakers and microphone are turned on (the default settings).
2. Check that the Speaker Volume and microphone sound levels on the Dashboard are appropriate for recording and playback.

**NOTE:** For more information about the Sound Recorder, select Help on the recorder window.

3. Check the microphone angle on the Motion Dashboard. The default is Medium Angle. You may want to change this to Wide so that more sound will be recorded. Even with a wider angle, the noise suppression feature will continue to remove background and ambient noises and microphone echo and feedback.



## Using the Microsoft Sound Recorder

1. Go to Start>All Programs>Accessories>Entertainment>Sound Recorder.
2. Tap the Record button to record. The timer shows how many seconds you have recorded.
3. Press Stop button to end the recording. Recorded sounds are saved as waveform (.wav) files.

**NOTE:** You can stop and restart a recording without recording over the previous one by pressing the Stop button. You have 60-seconds of recording time.

4. Press the right arrow button to play the recording.

## HINTS FOR DICTATING AND RECORDING

- You may want to start recording or dictating from the Wide Angle and change to a more-restricted angle (Narrow or Medium) if too many outside sounds are recorded. The advantage to the Wide Angle is that no sounds will be lost if you change your location. The disadvantage is that outside sounds may be picked up that interfere with the recording.
- You **MUST** recalibrate the microphones if you change from one orientation (landscape) to another (portrait). This is because the skew angle changes and the sound will no longer be in the angle of acceptance.

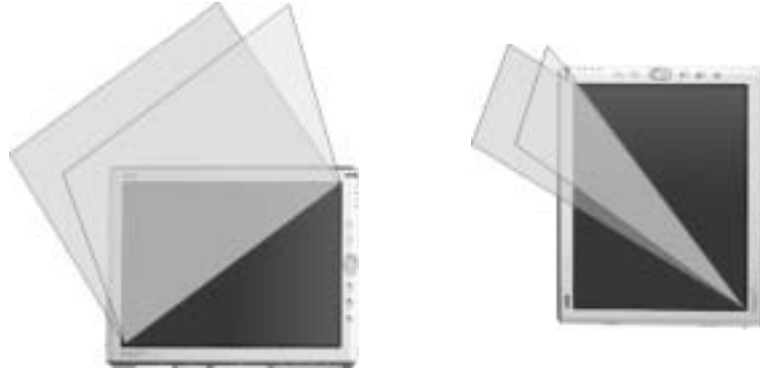

- Even with the Narrow Angle setting, if a sound is loud enough and within the angle of acceptance (no matter how distant), the sound will be picked up by the M1400 microphones. The advantage of the M1400 is that it detects fewer extraneous sounds than other audio systems. You can further limit the detection of these outside sounds by turning down the microphone volume and speaking louder; this reduces the microphones' range and restricts their ability to detect extraneous sounds.
- The M1400 contains Motion-installed audio components. If you install a third-party audio device (such as USB or Bluetooth), the Motion-installed audio may not work. If this happens, you must *reinstall* the Motion-audio components (that is, the SigmaTel® and Knowles Acoustics audio drivers). For information about installing these drivers, go to the Motion website at [www.motioncomputing.com/support](http://www.motioncomputing.com/support) and search the Motion Knowledge Base for audio drivers to download. After you install these, if you still have problems recording, contact Motion Technical Support or the Bluetooth or USB manufacturer's technical support.
- To improve speech recognition, run additional speech training sessions. Open the Windows Control Panel and select Speech to perform additional speech training. As you do this, speech recognition accuracy will gradually improve.

## MULTIMEDIA APPLICATIONS

Your Tablet PC supports most multimedia applications.

## ABOUT THE OMNIPASS PASSWORD MANAGEMENT SYSTEM

The fingerprint reader built into your Motion Tablet PC lets you scan your fingerprint to log onto your Tablet PC and perform other functions such as accessing email, e-banking, paying bills online, or accessing network resources. The OmniPass software offers a secure and convenient system for managing your passwords and providing confidentiality for your sensitive data through file encryption.

When implemented within the security policies of your work environment, the OmniPass authentication tools add another layer of security for your passwords, files, and other logons.



## OVERVIEW

The procedures for setting up the fingerprint reader are divided into basic and advanced options. For a more successful experience, start with the basic set up to become familiar with the scanning technique before setting the more advanced features.

Basic set up steps includes:

- Enrolling (your username and password)
- Selecting a finger
- Capturing a fingerprint

Advanced set up features include:

- User management
- User settings
- System settings
- Vault management
- Encrypting and decrypting files

Descriptions of these features may be found in the section “Advanced Fingerprint Reader Features” in this chapter. Or, read the OmniPass Help (tap Start>All Programs>Softex> OmniPass Control Center; double-click the OmniPass icon in the system tray, open the OmniPass Control Center and select Help).

## BASIC FINGERPRINT READER SET UP

These basic configuration steps will enroll you in OmniPass and let you log onto your Tablet PC with your fingerprint.

### ***Enrolling with OmniPass***

1. Tap start>All Programs>Softex>OmniPass Enrollment Wizard.

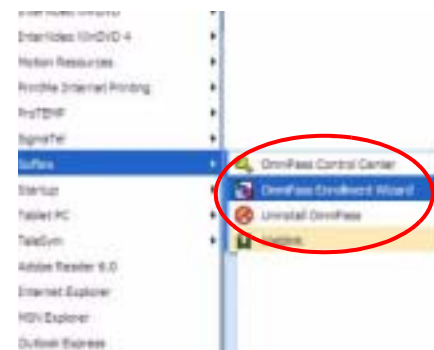

- From the enrollment window, tap Enroll.



- Type in the user name, domain, and the password (if you have one set up) for this OmniPass account. (This may default to the user name you logged on with and the password associated with it.)
- Tap Next.

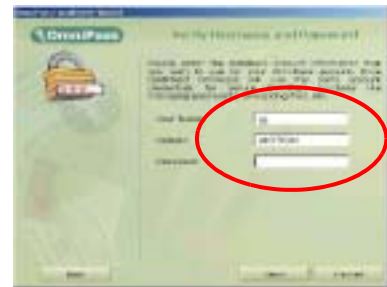

### Selecting a Finger and Practicing Fingerprint Capture

- When the Choose Finger window appears, tap the dotted area above the finger you want to enroll. A red arrow appears above the selected finger.



**IMPORTANT:** To get a feel for finger position and swipe speed, tap Practice. "Practice" takes you through all the enrollment steps and helps you get a successful fingerprint scan. See "Hints for a Successful Fingerprint Capture" after Step 8 for scanning suggestions.

- After you have practiced, tap Next.

### Capturing Your Fingerprint

7. From the Capture Fingerprint window, with the Tablet PC in landscape mode (horizontal), place your finger over the gold-colored ring (1) and slowly pull your finger down over the sensor (2) using moderate pressure on the sensor. Make sure your entire fingerprint touches both the gold ring and the sensor surface.

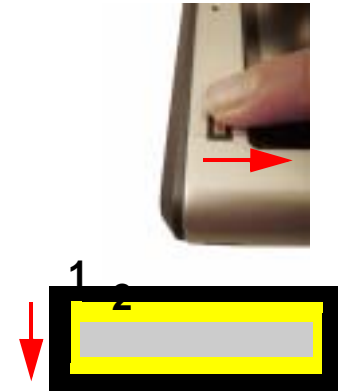

If the capture is successful, you will see a green fingerprint in the capture area.

If the capture is *unsuccessful*, an information message appears, such as “Scan too slow/too fast...” and the green fingerprint *will not* appear. Swipe your finger across the sensor again as many times as required for a successful scan.



**IMPORTANT:** Be consistent. Each time your scan, hold your finger and hand in the same position and slide it across the sensor at the same angle. Variations in angle, hand position, speed, and pressure affect how the fingerprint is read and may result in the fingerprint not being verified.

8. After the first scan is successful (and a green fingerprint appears), OmniPass prompts you to scan your fingerprint two more times. Wait until the green fingerprint disappears from the display and the fingerprint area is empty before swiping your finger again.

### HINTS FOR SUCCESSFUL FINGERPRINT CAPTURES

- Be consistent. Hold your finger and scan at the same angle each time. Example, if you enroll your finger with your hand open (or closed), hold your hand this way each time you scan. If you enroll your thumb while holding the edge of the Tablet PC while scanning, you need to scan like this each time.
- The scanner works in only one direction; that is, it only detects downward scans (with the sensor in the upper left corner of the unit).
- You can enroll with the Tablet PC in a 180° orientation (that is, rotated so the finger sensor is on the lower right corner of the Tablet PC), provided that when you scan to log on, the Tablet PC is in this same orientation.
- Read the prompts carefully and make sure you are waiting to be prompted before each swipe.
- Swiping too fast or too slow can make a capture unsuccessful. Change the swipe speed until you learn what speed works best.
- When scanning, press hard enough to fully contact both the gold ring and the sensor. You do not have to press hard.

- Rub your fingers together to stimulate the natural skin oils so your fingerprint is easier for the sensor to detect. Conversely, wipe your finger off so nothing interferes with the scan.
- Clean the sensor. First, power down the Tablet PC and remove the battery. Then, clean the sensor using a cotton swab sprayed with a window-type cleaner (no bleach, solvents, or abrasives); then dry the sensor. Do not spray, pour, or otherwise dispense any liquid directly on the sensor.
- Enroll a different finger. Some fingers have insufficient ridge information for a successful enrollment.

**NOTE:** If the fingerprint capture times out, tap Back. This restarts the enrollment process.

9. After OmniPass successfully captures three fingerprints, the Verify Fingerprint window appears. Swipe your finger one more time to complete the enrollment. When the messages “The selected finger has been enrolled in OmniPass” and “Successful Verification” and a green fingerprint appear, enrollment is complete.

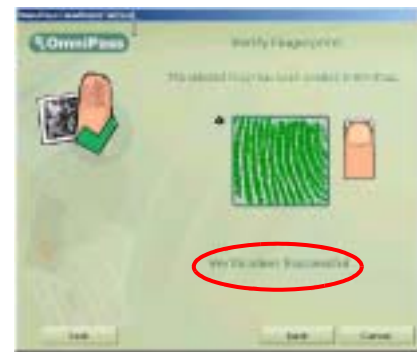

**IMPORTANT:** During the verification process, you may get red fingerprint images or the message “Verification Failed.” If this happens, tap the Back button and try again. You can have as many tries as you need for enrollment and verification. If needed, reread the section “Hints for Successfully Enrolling a Fingerprint.”



10. Tap Next.
11. When you are prompted to enroll a second fingerprint, tap Yes.

**IMPORTANT:** We recommend that you enroll a second fingerprint. A finger injury could prevent an authorization and block access to your accounts.

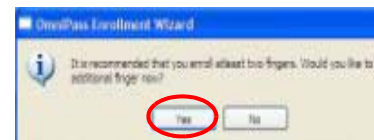

12. Repeat Steps 7-10 to enroll a second fingerprint.

13. Tap Next.
14. When the Set Authentication Rules window appears, leave the selections blank (the default).

**IMPORTANT:** Leaving the default notification options lets you enter a password should the system not be able to match your fingerprint. Notifications are advanced features that you can change later as you become accustomed to fingerprint authentication.



15. Tap Next. The Audio and Taskbar Settings window appears. You can leave the defaults or change the settings, as desired.
16. Tap Next. The Congratulations window appears. OmniPass recommends that you “Export” (backup or make a copy of) your user profile so you can restore a lost or corrupted OmniPass configuration or encryption keys. See the section “Exporting Your User Profile” for how to perform this backup.
17. Tap Done.
18. Tap Yes to log yourself on as a new user.

## ADVANCED FINGERPRINT READER FEATURES

OmniPass offers a number of advanced features that provide additional password management for your Tablet PC beyond the basic convenience of logging on.

**CAUTION:** Before configuring advanced features, please read the OmniPass Help, including any cautions or warnings about features. Activating some features (specifically Strong Logon Security) may, as a normal part of the OmniPass operation, change the way your Tablet PC starts up and/or the start-up options that are available. Before using advanced features, back up your user profile, as described in the section “Exporting/Backing Up Your User Profile.”

To access these advanced features, tap Start>All Programs>Softex>OmniPass Control Center. Or tap the OmniPass icon in the system tray and open the OmniPass Control Center. Here is an overview of these features. For further information, read the OmniPass Help.



- User Management — Import and export OmniPass user profiles; user profiles are stored as .opi (OmniPass Import/Export) files

**IMPORTANT:** To restore a lost or corrupted OmniPass configuration and encryption keys, back up and store a copy of your user profile(s) in a safe place.

- User Settings — Authentication rules for Windows and OmniPass logons, website passwords, encryption/decryption of files and folders, and user management; Audio; Taskbar Tips.

**NOTE:** For instructions for setting up passwords, see the section “Replacing Password Logons.”

- System Settings — Startup options for Windows; Strong Logon Security
- Vault Management — Password management for websites, applications, or any password-protected resource
- Encrypt/Decrypt — Settings for authenticating encrypted/decrypted files



### Checking Logon Status

A quick way to check if a user is logged on is by moving the cursor over the OmniPass key icon in the system tray. A popup shows who is logged on.



Or, tap the OmniPass key icon and open the OmniPass Control Center>User Settings tab and look at the Current User.



### Replacing Password Logons

OmniPass lets you replace the password logons at websites or anywhere you are prompted to provide your credentials, such as Internet email, ftp logons, client logons, or any restricted access network resource. Once OmniPass registers your logon credentials, you can conveniently access any of these restricted areas with your fingerprint. You can also access these sites with your password.

1. Go to a site that requires a log on (username and password), *but do not log on yet.*
2. At the site logon prompt, enter your username and password in the fields provided, *but do tap Enter, Submit, OK, or Logon or any other method that accesses the site.*
3. Right-click the OmniPass key icon in the system tray.
4. Tap Remember Password. The Windows arrow cursor will change to the OmniPass “golden key” cursor.
5. Drag this OmniPass cursor to the area on the site where you would normally enter your username and password to log on, *but do not tap “Logon” or “Submit” yet.* (You will complete the logon in Step 9.)



6. When the “Friendly Name” window appears, enter a name that reminds you of the website. OmniPass associates this name with this website.



7. Verify that the Settings for this Password Site are set the way you want the site authenticated:
  - **Automatically enter ...** — Instantly accesses the site without requiring a password or fingerprint scan
 

**NOTE:** This option bypasses password protection of the site (authentication). If you leave your system unattended and unlocked, this website can be viewed by anyone who has access to your Tablet PC.
  - **(Default) Automatically click ...** — Prompts you for your OmniPass/Windows password or fingerprint scan when you access the site
8. If needed, swipe your fingerprint or enter your master password to authenticate these settings.
9. Tap OK, Submit, Sign In, or Logon to access the site.
10. Tap Finish to complete the “Remember Password” procedure. The site location, the credentials to access the site, and the OmniPass authentication settings for the site are now stored in the OmniPass secure database.

## Logging Onto a Remembered Site

1. Open a website where you have set up the OmniPass logon (that is, a “Remembered Site”).
2. Swipe your finger when you are prompted for a fingerprint/master password authentication.

**NOTE:** You can remove a remembered site through the OmniPass Control Center’s Vault Management>Management Passwords option.

## Exporting Your User Profile

The OmniPass Help contains information about exporting your user profile. Go to Start>All Programs>Softex>OmniPass Control Center, and select Help.

### MICROSOFT SECURITY

The Microsoft Windows XP for Tablet PC Edition 2005 operating system provides security features that defend against viruses, worms, and hackers. To learn more about these features, tap the Windows Security Alerts icon on the system tray. A synopsis of these features can also be found in the section “Microsoft Security” in Chapter 3 of this *Guide*.

### SETTING UP TABLET PC SECURITY

Passwords protect your Tablet PC from unauthorized access. Passwords can create different levels of protection for your Tablet PC and its data.

- Operating system passwords — Secure the files on your Tablet PC from other users
- BIOS (Basic Input/Output System) passwords — Secure the software routines that test hardware at startup, start the operating system, and support the transfer of data among hardware devices
- System password — Locks access to the BIOS setup
  - Boot password — Locks access to the system
  - HDD (Hard Disk Drive) password — Secures your data so the Hard Disk Drive cannot be accessed by removing it and connecting it to another Tablet PC

## Setting the Windows Operating System Password

You can set up a Windows operating system password going to Start>Control Panel>User Accounts>Create a new account... (Classic View).

## Setting BIOS Passwords



**CAUTION:** We strongly recommend that you read the information in this section carefully to understand the implications of setting up a BIOS system password. If you set up a BIOS System password and enter it incorrectly several times, you will be locked out of the system. If you become locked out, you can restart the Tablet PC and retry the password again. You can restart the Tablet PC and re-enter the password as many times as you need to. However, if you are unsuccessful in entering the password, you will not be able to access your Tablet PC.

If this happens, contact Motion Computing Technical Support at [www.motioncomputing.com/support](http://www.motioncomputing.com/support) for assistance. Have your Tablet PC Serial number available (located on the label on the back of the system).

The level of security you want on your Tablet PC helps determine what BIOS password(s) you set.

### BIOS System Passwords

To set up a password to access the PhoenixBIOS™ Setup Utility on the Tablet PC:

**NOTE:** These procedures describe using the pen to enter information; you can also attach an external keyboard if you prefer.

1. Start the Tablet PC.
2. When the Motion Computing Splash Screen appears, quickly press Hot Key #2 (2). If you miss the Splash screen, turn the Tablet PC off then back on and try this step again.
3. From the PhoenixBIOS Setup Utility, tap Security on the menu bar.
4. **To set up a System password**, double-tap Enter next to Set System Password.
5. Type in a System Password using the onscreen keyboard.
6. Tap Enter.
7. Type in the password again to confirm it.
8. Tap Enter. The system returns to the Security screen and the System Password reads Set. A password is now required to enter the PhoenixBIOS Setup Utility.
9. **To set up a Password on boot**, tap Disabled next to Password on boot until Enabled is highlighted. You will not be prompted to type in another password because Password on boot uses the System password.

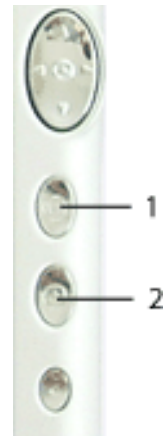

**NOTE:** You cannot set up Password on boot until you set up a System password.

10. If you have finished setting up a password, tap Exit or press the Esc key on the Tablet PC to exit the PhoenixBIOS Setup Utility.
11. When you exit, you are prompted to select from the following options:
  - Exit Saving Changes
  - Exit Discarding Changes
  - Load Setup Defaults
  - Discard Changes
  - Save Changes
12. Select the desired action.

13. Confirm the selection by tapping Yes.

### Hard Disk Drive (HDD) Password

To set up a password to start the Tablet PC (so no one can access the information on the Hard Disk Drive of your Tablet PC even if it is removed and installed in another Tablet PC without the proxy password):

1. Start the Tablet PC.
2. When the Motion Computing Splash Screen appears, quickly press Hot Key #2 (2). If you miss the Splash screen, turn the Tablet PC off then back on and try this step again.
3. From the PhoenixBIOS Setup Utility, tap Security on the menu bar.
4. **To set the hard disk password**, double-tap Enter next to Set Hard Disk Password.
5. Type in a New Password.
6. Tap Enter.
7. Type in the password to confirm it.
8. Tap Enter. The system returns to the Security screen and the HDD Password is Set. (When you exit then re-enter the PhoenixBIOS setup, the HDD Password is Locked.)
9. If you have finished setting up a password, tap Exit or press the Esc key on the Tablet PC to exit the PhoenixBIOS Setup Utility.
10. When you exit, you are prompted to select from the following options:
  - Exit Saving Changes
  - Exit Discarding Changes
  - Load Setup Defaults
  - Discard Changes
  - Save Changes
11. Select the desired action.
12. Confirm the selection by tapping Yes.

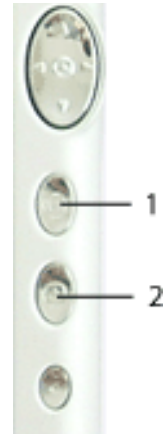

## CLEARING TABLET PC SECURITY

To clear the Tablet PC PhoenixBIOS security:

1. Start the Tablet PC.
2. When the Motion Computing Splash Screen appears, quickly press Hot Key #2. If you miss the Splash screen, turn the Tablet PC off then back on and try this step again.
3. From the PhoenixBIOS Setup Utility, tap Security on the menu bar. If you have rebooted, you will be prompted to enter the password(s) you have set up.
4. To clear the System and Password on boot passwords, double-tap Enter next to Set System Password.
5. Type in the Current Password.
6. Leave the space blank next to Enter New Password.
7. Tap Enter.
8. Leave the space blank to Confirm New Password.
9. Tap Enter.
10. When the Security screen appears, the System Password should be Clear and the Password on boot Disabled.
11. To clear the Hard Disk Drive password, double-tap Enter next to Set Hard Disk Password.
12. Type in the Current Password.
13. Leave the space blank next to Enter New Password.
14. Tap Enter.
15. Leave the space blank to Confirm New Password.
16. Tap Enter.
17. When the Security screen appears, the HDD Password should now display Clear.

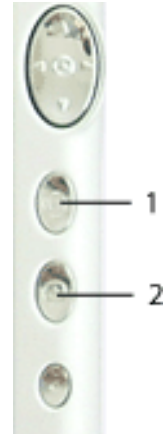

## CARING FOR YOUR TABLET PC AND ITS ACCESSORIES

The Tablet PC display and chassis are designed to be very durable. This section describes the proper care and maintenance that will keep them working and in good condition for a long time. For general information about care of the Tablet PC and its components and accessories, see the *Regulatory and Safety Guide* packaged with your Tablet PC.



**CAUTION:** Be sure to follow the guidelines listed below when caring for your Tablet PC and its components. Improper use may damage the Tablet PC and/or its components and void the warranty.

### General Care

- Protect the Tablet PC from exposure to extreme temperatures, shock, liquids, and strong magnetic fields.
- Do not open or disassemble the Tablet PC other than to replace memory modules or to replace the battery. Always follow the instructions included with these accessories when performing these procedures.



**WARNING:** To avoid the risk of personal injury or damage to the Tablet PC, when replacing memory modules, turn off your Tablet PC, unplug the AC power connection, and remove the battery. Ground yourself by touching a grounded conductive surface, such as a device or appliance with a grounded, three-pronged plug. Avoid touching the pins and leads on the memory and the internal circuitry of the Tablet PC. See the section “Adding Memory” in this chapter for more information about replacing or adding memory modules.

- When storing the Tablet PC for an extended period of time, unplug AC power and remove the battery after discharging it part way.
- Do not place heavy objects on top of the Tablet PC.

### Caring for the Standard and View Anywhere Displays

- General cleaning of either display — Clean fingerprints and most marks from the display surface by wiping it with the soft cloth (provided). Never spray or pour liquids directly onto the display surface itself. Never use an abrasive cleaner on the display. If liquid is spilled on the display, wipe it up immediately.
  - Cleaning the standard display — If needed, spray a soft cloth (not directly on the display) with a window-type cleaner and wipe the display.
  - Cleaning the View Anywhere Display — If needed, clean with any alcohol-based product recommended for use on anti-reflective glass. Other cleaning products may leave a residue.
- Avoid using tissues or paper towels to clean the display surface. These contain wood fibers that can scratch the display.
- Use only the Motion Digitizer Pen on the display. Do not write on the surface with an ink pen or pencil, any pointed or other object that could damage the display surface.
- Do not place heavy objects on the display surface.
- Protect the display surface from unnecessary contact by using the Hard-top Cover or a portfolio when transporting the Tablet PC.
- Avoid exposing the display to direct sunlight for long periods of time.

### Caring for the Motion Digitizer Pen

- Always store the Motion Digitizer Pen in the Tablet PC pen bay or in the portfolio when not in use.
- Do not store the pen vertically on the tip. Constant tip pressure can affect the pen-to-digitizer interaction.
- Change the pen tip regularly. See the **CAUTION** and the section “Replacing the Pen Tips.”



**CAUTION:** Certain environments may contain particles or debris that can adhere to the Tablet PC display or to the pen tip. To avoid damaging the display, clean it frequently with the cleaning cloth, provided with your system. Also, change pen tips regularly, especially if you drop the pen onto a rough surface that could damage the tip or embed debris in it. Damaged pen tips can scratch the display. Consider using a Motion Slip Case to protect the display and the pen.

- The pen contains sensitive electronics. Do not immerse it in liquids.

### Replacing the Pen Tips

Normal use eventually wears down the pen tip, so the pen ships with extra tips and a small “tip tool” for replacing them.

1. Grasp the old tip with the silver ring of the tip replacement tool (1).
2. Pull the old tip out of the pen.
3. Insert a new tip (2).
4. Apply slight pressure to push it into place.



### Ordering New Pens

To order additional pens, visit the Motion Computing website at [www.motioncomputing.com/accessories](http://www.motioncomputing.com/accessories).

## TRAVELING WITH YOUR TABLET PC

Here are some tips for traveling with your Tablet PC:

- Remove all accessories and cables. Remember to pack those you will need while traveling and do not forget to pack at least one Motion digitizer pen.
- Attach the Hardtop Cover or slip the Tablet PC into a portfolio to protect the display.
- Protect the pen by keeping it in the Tablet PC pen bay or portfolio case during travel.
- Pack the Tablet PC securely in a briefcase or hand-carried luggage, and keep it separate from toiletries, liquids, and food. Do not pack it in checked luggage when you travel.
- Keep the Tablet PC stable during travel; secure it to prevent it from sliding around in overhead bins and car trunks.

**NOTE:** For travel warnings, see the section “FAA Wireless Air Travel Requirements” in this chapter.

### Traveling by Air

- Prepare for airport security by charging the battery in the event Security asks you to start the Tablet PC.
- Have it hand-inspected or sent through the X-ray scanner, but never carry it through the metal detector.

- Either turn off or place the Tablet PC in hibernation for takeoff and landing.

### FAA Wireless Air Travel Requirement



**WARNING:** The FAA requires that you suspend wireless operations, such as 802.11 and Bluetooth, before boarding the plane. The easiest way to disable *internal*/wireless operations is by unchecking (disabling) all wireless devices in the Motion Dashboard. The wireless LED on the Tablet PC front panel, shown here, is off when wireless communications



are disabled. To disable *external*/wireless operations, remove any installed wireless PC Cards.



**WARNING:** Do not transport the lithium ion batteries used in your Tablet PC in checked baggage. You may take up to two spare batteries in carry-on luggage in addition to the one in your Tablet PC. Transporting batteries in checked baggage or transporting more than two spare batteries is a violation of transportation regulations.

### Other Travel Hints

- Before extended use in the field or long trips away from AC power, adjust the Power properties to maximize battery conservation. Right-click the Power/Battery icon in the system tray to open the Power Options Properties dialog box. Then adjust the options. For more information, see the section “Changing the Default Power Scheme” in this chapter. Or see the Performance and Maintenance section of the Help and Support Center for details about power settings.
- For international travel, obtain and use the appropriate adapters for your destination’s electrical outlets. A current converter is not necessary.
- You may want to carry proof of ownership or a merchandise passport when traveling internationally.
- Consult your insurance company and credit card company to learn about emergency travel assistance in the event your Tablet PC becomes lost or disabled.

# Appendix A

## Troubleshooting and Support

All Motion Computing Tablet PCs have passed a rigorous series of performance and quality-control tests, but now and then a problem may occur. If you do not see a solution among the following system and software issues, check the section “Support Options” in this chapter or go to our website at [www.motioncomputing.com/support](http://www.motioncomputing.com/support).

### SOLUTIONS

PROBLEM	CAUSE	SOLUTION
<b>POWER</b>		
The Tablet PC won't start when I slide the Power switch.	The Power switch hasn't been fully engaged.	Slide and hold the power switch for at least a half-second, but no more than three seconds.
	Fully discharged battery or no battery and no AC power.	Connect the AC adapter to operate the Tablet PC and charge the battery.
The Tablet PC won't shut down.	An application has locked up the Tablet PC.	Press the Security button (small button with a key icon) to start Windows Task Manager and close the application.
		Slide and hold the power switch for at least 5 seconds to force a shutdown of the Tablet PC.
The Tablet PC won't enter Hibernation mode.	Hibernation isn't enabled.	Enable Hibernation through Power Option Properties.

The Tablet PC won't come out of Hibernation mode when running on battery power.	Fully discharged battery and no AC power.	Connect the AC adapter to provide power to the Tablet PC and charge the battery.
<b>PROBLEM</b>	<b>CAUSE</b>	<b>SOLUTION</b>
<b>POWER (CONTINUED)</b>		
The display goes black while the Tablet PC is still turned on.	The Tablet PC system has gone into stand by after sitting idle for a period of time. (In this state, the power LED flashes green.)	Slide the power switch for about a second to resume operations.
	System has gone into low-battery Hibernation mode. (In this state, the power LED is off.)	1. Slide the power switch for about a second to resume operations. 2. Connect the AC adapter to the Tablet PC to charge the battery.
<b>BATTERY</b>		
Data loss during battery swap.	The unit is designed to maintain the data and settings for up to 30 seconds in stand by while you swap the battery. This time may vary due to your system and the programs you're running.	When you swap the battery with the unit in stand by, be sure to save your data before removing the battery to avoid data loss.
The battery seems to run down very quickly (lasting less than three hours after a full charge).	Accessory devices such as a DVD player and applications that make heavy use of the hard drive drain the battery more quickly.	Use AC power when possible and/or turn off the accessory devices.
	The battery is weakening or defective.	All batteries weaken in time, but if a new battery is needed, visit the Motion website to order a new battery.
<b>DISPLAY</b>		
The desktop is too big for the display – I can't see all of the desktop icons.	Screen resolution is set higher than the default 1024 x 768 with 32-bit resolution.	Decrease the screen resolution by opening the Motion Dashboard, selecting Graphics Properties, then the Schemes tab.
When I disconnected a second monitor from the Tablet PC, the image became too big for the Tablet PC display.	The Tablet PC has attempted to spread the image of a window or desktop beyond the screen area of the active monitor.	1. Tap the Properties button on the Motion Dashboard. 2. Tap Graphics Options, then Graphics Properties... to open the Properties screen. 3. Select Notebook to make the Tablet PC the primary display.

The display looks dim.	Brightness is set too low.	Adjust brightness from the Motion Dashboard.
The screen is unreadable or distorted.	Screen resolution and/or color quality are set incorrectly.	Reset resolution to 1024 x 768 and color quality to 32-bit by opening the Motion Dashboard, Graphics Properties, then the Schemes tab.
	Display driver has become corrupted or uninstalled.	<ol style="list-style-type: none"> <li>1. Open the Windows Control Panel, select Performance and Maintenance (Category View) or System (Classic View).</li> <li>2. Select the Hardware tab.</li> <li>3. Select Device Manager.</li> <li>4. Open Display adapters.</li> <li>5. Double-tap on an adapter.</li> <li>6. Select the Driver tab.</li> <li>7. Choose Update Driver... and follow the Installation Wizard.</li> </ol>
<b>PEN</b>		
The Tablet PC digitizer screen doesn't respond to the plastic stylus I use on my PDA.	You're using the wrong input device.	Only the Motion Digitizer Pen lets you write on the Tablet PC display. The Tablet PC doesn't respond to other tablet pens or to a plastic stylus.
The Motion Digitizer Pen tip doesn't line up with the arrow-cursor when I tap on the screen.	The pen and display need recalibrating.	Open the Motion Dashboard and select Calibrate Digitizer.
When I write, I unintentionally click the pen function button while I'm writing with the pen.	You're pressing the pen button with your thumb or finger when you write or gripping the pen too tightly and accidentally pressing the pen button. This enables the right-click function of the pen.	<p>Try these hints:</p> <ul style="list-style-type: none"> <li>• Readjust how you hold the pen. Place your fingers on either side of the pen function button when you write.</li> <li>• Practice using the pen function button with both your index finger and thumb to see which you prefer.</li> <li>• Relax your grip. Only a light touch is needed to write with the pen.</li> <li>• Deactivate the pen right-click function through Tablet and Pen Settings. Instead, press and hold the pen to the display surface to right-click.</li> </ul>

PROBLEM	CAUSE	SOLUTION
<b>PEN (CONTINUED)</b>		
The pen button doesn't work. I can't get it to right-click.	The right-click option for the pen button may be deactivated.	Re-activate the right-click option: Double-click the Tablet and Pen Settings icon, select Pen Options, and reselect Use pen button to right-click. Select Apply>OK.
	You may not be correctly timing clicking the pen button and tapping the pen on the display.	To right-click, hold the pen button down and then firmly tap on the display.
The buttons on the Tablet PC don't do what I expect them to do.	Button functions have been changed.	Double-tap the Tablet and Pen Settings icon, then Tablet Buttons. You can reset the buttons to the defaults. NOTE: Button functions are associated with the orientation in which they're programmed.
<b>INTERFACE/PORTS</b>		
The system doesn't recognize the PC card I've inserted.	The card is incorrectly inserted.	Eject the card and re-insert it with the label side up.
	The device is not supported.	Check Windows XP compatibility.
The system doesn't recognize a USB or IEEE 1394 device.	Windows XP may take a short time to recognize the device.	Wait until Windows XP recognizes the device.
	The accessory isn't connected to the Tablet PC correctly.	Check the connection cable and be sure it is inserted into the correct port on the Tablet PC and the accessory device.
	The correct driver isn't built into Windows XP.	Use the device's installation CD or check the manufacturer's website for the correct driver.
The Tablet PC is sitting in the Motion FlexDock, but the system doesn't recognize any accessory devices, such as the external monitor or CDROM.	The Tablet PC isn't fully seated in the Motion FlexDock.	Reseat the Tablet PC in the Motion FlexDock.
<b>AUDIO</b>		
No sound is coming from the built-in speakers.	Connecting a headset or external speakers mutes the built-in speakers.	Disconnect the headset or external speakers if not in use.

No sound is coming from any speakers.	Audio volume is too low or has been muted.	Open the Motion Dashboard and adjust the speaker volume by sliding the volume slider or uncheck the Mute button.
PROBLEM	CAUSE	SOLUTION
OPERATING SYSTEM		
I've forgotten my BIOS password and can't access my system.	The Tablet PC will let you enter several passwords incorrectly before it temporarily locks the system.	Turn the Tablet PC off and back on and try re-entering your password (you can do this as many times as needed). If you have forgotten your password, contact Motion Computing Technical Support for information about unlocking your system at <a href="http://www.motioncomputing.com/support">www.motioncomputing.com/support</a> .
The program I'm working in has stopped responding, but the cursor moves and other programs work.	The program has crashed.	Press the Security button (small button with a key icon) on the Tablet PC front panel to open the Task Manager and end the non-responsive program.
The system seems to be operating more slowly than usual.	The hard disk drive is full or nearly full.	Run the Disk Cleanup utility to clear out unnecessary and temporary files. Remove unneeded programs and files.
	The disk needs defragmenting.	Run Disk Defragmenter to consolidate files and folders on the hard drive. Consult the "Performance and Maintenance" section of the Microsoft Help and Support Center.
COMMUNICATIONS		
The wireless communication keeps connecting even when I don't want it to.	The default setting is On.	Uncheck the wireless checkboxes in the Motion Dashboard.
Data doesn't transfer through the wired Ethernet cable.	The Ethernet cable is not connected correctly.	Reconnect and check the activity LEDs next to the LAN (RJ-45) port. They should flash green and amber.

**FAQs****How long will the battery stay charged?**

This can vary according how you're using the Tablet PC, but a new, fully charged standard Motion 6-cell battery can last about 4 hours.

**Can I make the battery charge last longer?**

- Change to the Max Battery power scheme (right-click on the Power/Battery icon in the system tray—located in the lower-right corner of the display window—and tap Adjust Power Properties; under Power schemes, tap Max Battery). The Tablet PC comes with Motion Computing Optimized as the default power scheme.
- Turn on the Ambient Light Sensor on the Motion Dashboard. This will dim the display automatically (when possible) and save battery power.
- Dim the display brightness by opening the Motion Dashboard and moving the Display Brightness slider. (You can also double-tap on the Tablet and Pen Settings icon in the system tray and choose the Display tab to get this brightness slider.)
- Disconnect LAN/modem connections and disable wireless communications when not in use (uncheck the Wireless checkboxes in the Motion Dashboard).
- Turn off optional and unnecessary background programs and turn off or unplug accessory equipment from the USB and IEEE 1394 ports.

**What does the Tablet PC need for use in another country?**

Just an outlet adapter, which you can find in airports and travel stores. The AC adapter will adjust automatically to different voltages when plugged into the correct location-appropriate power adapter.

**What's the best way to clean the standard display screen?**

To clean the acrylic display screen, wipe it with a soft cloth (like the one supplied) onto which you have sprayed a window-type cleaner. Do not spray cleaners, spray/pour any liquid, nor wipe any abrasive cleaner on the screen nor any surface of the Tablet PC. Do not use tissues or paper towels to clean the screen. They contain wood fibers and may scratch the surface.

**How should I clean the View Anywhere display screen?**

To clean the View Anywhere display screen, wipe it with a soft cloth (like the one supplied). If needed, clean with any alcohol-based product recommended for use on anti-reflective glass. Other cleaning products may leave a residue. Do not spray cleaners, spray/pour any liquid, nor wipe any abrasive cleaner on the screen nor any surface of the Tablet PC. Do not use tissues or paper towels to clean the screen. They contain wood fibers and may scratch the surface.

**Will scratches affect the display/digitizer's performance?**

Testing has not found appreciable loss of performance on a scratched display.

**How sensitive is the screen to s the elements?**

As with any computer or electronic device, the Tablet PC should be protected from liquids, dirt and sand, other contaminants, and extreme heat.

**Will the Tablet PC work with any monitor or USB accessory keyboard, mouse, disk drive, etc?**

As long as the device's driver is available either in the Windows XP operating system or from the manufacturer and it carries the Windows XP logo or certification, it should work with your Tablet PC. For more information, see [www.microsoft.com/help](http://www.microsoft.com/help).

**Why doesn't the Tablet PC or FlexDock have parallel, serial, or PS2 (mouse) ports?**

Microsoft Tablet PC certification requires the system to be completely Grab-and-Go—that is, to be able to dock with and undock from all accessories without putting the system into suspend or shutting it down. Connection through legacy ports (serial, parallel, PS2) often requires suspending or restarting the system, which prevents you from moving between desktop mode and mobile mode seamlessly in one docking/undocking step.

**How do I adjust the Tablet for left-handed use?**

Double-tap on the Tablet and Pen Settings icon in the system tray, located in the lower-right corner of the display window, which opens the Settings window. You can change handedness as well as the location of the menus. Then, recalibrate the pen.

**MOTION  
WARRANTIES****Standard and Extended Warranty and Insurance Programs**

Motion Computing currently provides limited warranties on Motion products and accessories. See the Warranty packaged with your Motion product or accessory or visit our website at [www.motioncomputing.com](http://www.motioncomputing.com).

In addition, Motion Computing offers extended warranties along with various screen and configuration insurance programs. Visit our website at [www.motioncomputing.com/support](http://www.motioncomputing.com/support).

**MOTION  
COMPUTING  
SUPPORT**

If you need assistance or answers to frequently asked questions about your Motion Tablet PC, visit [www.motioncomputing.com/support](http://www.motioncomputing.com/support). We also offer a Knowledge Base of additional information that may help with your problem.

# Appendix B

## Motion Tablet PC Specifications

Motion M1400 Tablet PC	
CPU	Intel® Pentium® Processor, Ultra Low Voltage (ULV)
Chipset	Intel 855GME with up to 64MB allocated to video RAM
System Memory	256MB base RAM (maximum 1.5GB); two PC2700 DDR SODIMM slots
System Storage (Hard Disk Drive)	20GB (standard), upgradeable at time of purchase
I/O	Audio: two audio jacks Ports: two USB 2.0 ports; one IEEE 1394; one RJ-11; one RJ-45; one VGA monitor; one docking connector
Front Panel Buttons	(Buttons are numbered from top to bottom in primary landscape orientation.) Button 1: Primary function=Esc; secondary function=Alt+Tab (programmable) Button 2: Function (non-programmable) Button 3: Five-way directional control (programmable) Button 4: Primary function=Motion Dashboard (programmable); secondary function=Windows Journal (programmable) Button 5: Primary function=Rotate display; secondary function=Tablet PC Input Panel (TIP) (programmable) Button 6: Security (Ctrl+Alt+Del) (non-programmable)
PC Card Controller	Industry-standard cardbus controller
PCMCIA card slot	Single Type-II PCMCIA Cardbus slot
PC Audio	Two built-in speakers and two built-in microphones; SigmaTel® 9758 audio codec Universal Jacks™
Displays	12.1" XGA TFT LCD (1024 x 768) wide view display; (Optional) wide view with the View Anywhere™ option
Ambient Light Sensor (ALS)	Measures environmental light for automatic backlight adjustment
Graphics	Intel 855GME integrated graphics with UMA rotational support Rotation: 0°, 90°, 180°, 270° External Monitor Resolution Support: 1800 x 1440 (maximum)
Communications	
Ethernet LAN	10/100: Realtek™ RTL8100BL LAN on the daughterboard
Modem	PCTEL® MDC V.92 56.6Kbps/14.4Kbps transceiver fax

Wireless	Wi-Fi®: Intel 802.11b/g; Broadcom 802.11a/b/g (U.S. and Canada only); Bluetooth: Motion Computing USB Bluetooth Device
	Active digitizer pen (no battery required) with function button
Security	Integrated AuthenTec® fingerprint swipe sensor
Docking	Motion FlexDock docking station. Features include: microphone-in; headphone-out; DC power in; three 2.0 USB ports; IEEE1394 connector; RJ-45 connector; VGA connector (for external monitor); docking connector to the Tablet PC; cut-out access for a modem (RJ-11) on the Tablet PC
Battery/Power Management	
Battery Type	Six prismatic lithium ion (Li-ion) cells; Smbus control; 40Whr capacity
Battery Life	Six-cell battery: Maximum 3-4+ hours
Battery Charging Time	Approximate charging time of 2 hours (Tablet PC on); 1.2 hours (Tablet PC off)
Battery Charger (optional accessory)	Motion Multi-Unit Battery Charger: Nominal Input Voltage=19VDC; nominal output voltage=12.5V; operating ambient temperature: 0°C to +40°C (+32F to +104°F); storage temperature: -2°C to +70°C (+28°F to +158°F)
AC Power Adapter	50W universal, 2-pin jack, 90~264V AC, 47-63Hz
LED System Status Indicators	Power/stand by; battery status; hard drive access; wireless activity
Software (standard)	Microsoft Windows XP Tablet PC Edition; Adobe Acrobat; Motion Computing Dashboard; Bluetooth application software; Knowles IntelliSonic; Intel PROSet for Wireless; OmniPass Fingerprint sensor software; online documentation; drivers
BIOS	Flash BIOS ROM; password protection for the system and Hard Disk Drive; ACPI 1.1 compliant; pen/button/keyboard-based setup utility
Environment	Operating Temperature: +5°C to +35°C (+41F to +95°F) Storage Temperature: -20°C to +60°C (-4F to +140°F) Humidity: 10% to 90% without condensation Operating Altitude: 0 to 10,000 feet Storage Altitude: 0 to 40,000 feet
Physical Characteristics	
Size	296.0mm x 240.0mm x 22.0mm (11.7" x 9.4" x 0.90")
Carrying Weight	<1.36KG (3.0 lb) (in selected configurations)
Optional Accessories	New accessories may be added from time to time. For a list of the currently available accessories, see the Motion website at <a href="http://www.motioncomputing.com/accessories">www.motioncomputing.com/accessories</a> .
Service/Support	
Motion Computing Support	Contact your Motion Computing reseller or go to the Motion Computing support website at <a href="http://www.motioncomputing.com/support">www.motioncomputing.com/support</a> .
Agency Certifications	
Emissions	FCC 15, Class B EN55022 (CISPR22) Class B EN55011 ICES-003 Class B ETS 300 328 ETS 300 826 IC RSS 210
Immunity	EN55024
Safety	UL and CUL, UL1950 CSA C22.2 EN60950 C-Tick compliant
Telecom	FCC Part 68 IC CS03